

# STATE ENTERPRISES



Blind Rivets

*Weld-Less Fastening Systems..*



[www.rivetsindia.com](http://www.rivetsindia.com), [www.fastfix.in](http://www.fastfix.in)



BLIND RIVET



## CERTIFICATE OF REGISTRATION Quality Management Systems

### STATE ENTERPRISES

43, Street No- 1, Samaipur Industrial Area,  
Delhi-110042, India

Equalitas Certifications Limited Certifies that the Management System of the above mentioned Company has been assessed and meets the requirements established by the following rules:

# ISO 9001:2008

The Management System Includes :

Trading of Blind Fasteners,  
Technical Support & After Sales Services

Certificate No: Q-01150819

Original Issue Date: 19 Aug 2015

Issue Date: 19 Aug 2015

1<sup>st</sup> Surv. Due Before: 11 Aug 2016\*

2<sup>nd</sup> Surv. Due Before: 11 Aug 2017\*

Valid Till: 18 Aug 2018

\* After successful completion of surveillance audit, new certificate shall be issued.

In the course of validity of the present certificate the enterprise management system must permanently satisfy the requirements of the international regulations. The fulfilment of these regulations will be regularly controlled by Equalitas Certifications Limited.



  
Director

## Equalitas Certifications Limited

Accreditation by Joint Accreditation System of Australia and New Zealand (Accreditation No. M441021011)

FECCA House, 4 Phipps Close, Deakin, ACT 2600, Australia

For precise and updated information concerning possible changes occurred in the certification objective of the present certificate, please contact- info@theecd.com

The Certificate of Registration remains the property of Equalitas Certifications Ltd. and shall be returned immediately upon request.

817, Ansals Kirti Shikhar, 11 District Centre, Janakpuri, New Delhi-110058, India

## COMPANY PROFILE

### We ensure qualitative products and solutions

State Enterprises is a leading name in offering blind fasteners, with its Head Office situated in Delhi. Being an importer and distributor of exclusive blind fasteners, the company provides an array of Blind Rivets, Rivet Nuts, Self Drilling Screws, Self Clinching Fasteners and Riveting Tools.

We also provide industrial fasteners and fastening systems to the automotive, aircraft, switchgear, white goods and electronics industries in India. In addition we have Authorized Distributors in Bangalore, Bombay, Calcutta, Madras, Hyderabad and Pune.

Our approach of marketing, dealership and service network, ensure a high degree of consumer satisfaction and excellent after sales service to the end user. Our alignment and attention to customer centric approach has helped us to remain unbeaten in providing state-of-the-art services added with an excellent after sales and technical support.

State Enterprises offer India's largest range of products and permanently stock 40 million pieces. Our Research and Development Department takes utmost initiative in assisting many of the major manufacturers in finding solutions for their products. And our quality measures assure the qualitative products and services to our valued customers.

## VISION

To be the partner of choice in hardware top quality products and fittings for every selected domain, so as to be a major role-player in the development of the country.

## MISSION

To compete with the global players and facilitate products & solutions which are at par with international standards.

## QUALITY

State Enterprises success has been and will continue to be based on a commitment to provide its customers with the best quality products and services available. As the needs of industrial customers have changed, State Enterprises has invested in its people, equipment and technology necessary to continue its tradition. Our expertise has enabled us to guarantee constant operational quality.



## **We Assure Quality**



<b>Blind Rivet Technical Information</b>	<b>Page - A</b>
<b>Blind Rivet Applications</b>	<b>Page - B</b>
<b>Selecting Correct Type of Blind Rivet</b>	<b>Page - C</b>
<b>State Enterprises Breakstem Systems</b>	<b>Page - D</b>
<b>State Enterprises Trouble Shooting Guide</b>	<b>Page - E</b>
<b>Colored Blind Rivets</b>	<b>Page - F</b>
<b>Open Type Blind Rivet</b>	<b>Page - 1-2</b>
<b>Close Type Blind Rivet</b>	<b>Page - 3-4</b>
<b>Multigrip Rivet Aluminium</b>	<b>Page - 5-6</b>
<b>Multigrip Rivet Steel &amp; Stainless Steel</b>	<b>Page - 7</b>
<b>Tri-Fold Blind Rivet</b>	<b>Page - 8</b>
<b>Bulb-Tite Rivet Aluminium</b>	<b>Page - 9</b>
<b>Bulb-Tite Rivet Steel &amp; Monel</b>	<b>Page - 10</b>
<b>H-Lock Steel &amp; Aluminium</b>	<b>Page - 11</b>
<b>M-Bolt Aluminium</b>	<b>Page - 12</b>
<b>M-Bolt Steel</b>	<b>Page - 13</b>
<b>M-Bolt Stainless Steel</b>	<b>Page - 14</b>
<b>I-Lock Steel</b>	<b>Page - 15</b>
<b>I-Lock Stainless Steel &amp; Aluminium</b>	<b>Page - 16</b>
<b>St-Bulb Blind Rivet &amp; St-Nox Blind Rivet</b>	<b>Page - 17</b>
<b>Peel Type Blind Rivet</b>	<b>Page - 18</b>
<b>Rivet-Mate</b>	<b>Page - 19</b>
<b>Earth Type Blind Rivet</b>	<b>Page - 20</b>
<b>Blind Rivet Tools</b>	<b>Page - 21-24</b>



## Blind Rivet

A Blind Rivet consists of two parts – the rivet body and, within it, the setting mandrel, as shown in the accompanying drawing.

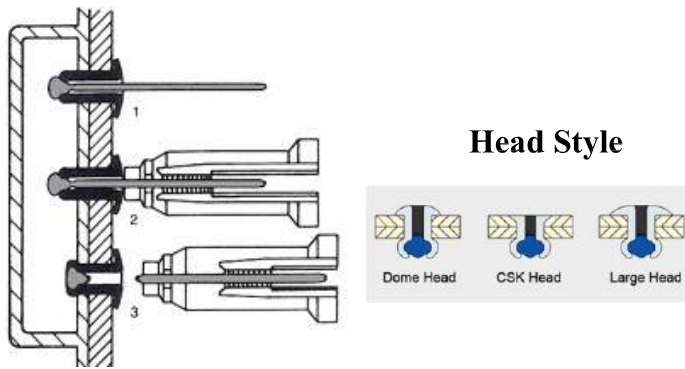

1. The rivet body is inserted in a hole in the materials to be joined.
2. The tool is actuated and the jaws of the power operated or manual riveting tool grips the mandrel of the rivet.
3. The rivet is set by pulling the mandrel head into the rivet body, expanding it, and forming a strong, tight, reliable joint. At a predetermined setting force, the mandrel breaks and falls away.

**ADVANTAGES OF BLIND RIVETS.** The ability to set blind rivets without the need for access at the back of the work makes their use mandatory in many instances. However, there are many additional advantages that make blind rivets the logical choice in numerous applications where the blind-setting feature is not of primary importance. Following are some of these important blind rivet advantages compared with conventional fasteners.

**LOW IN PLACE COSTS.** Real of “in place” cost are often lower than those of other fasteners because of their speed and ease of application.

**FAST ASSEMBLY.** Because blind rivets can be set in second Literally

**LOW-COST, LIGHTWEIGHT, EASILY PORTABLE TOOLS.** Manual or power tools are easy to take to the work place, reduce operator fatigue, and minimize capital expenditure.

**STRONG, RELIABLE FASTENINGS, INDEPENDENT OF OPERATOR SKILL.** Blind Rivets don't torque out like threaded fasteners, wasting time and material. Correct setting pressure is predetermined by the breaking point designed into the mandrel. So you get uniformly strong, reliable fastenings the first time-all the time.

**VIBRATION-PROOF ASSEMBLY.** Blind rivets won't back out or vibrate loose and fall out like threaded fasteners. You eliminate costly call-backs due to faulty fastenings.

**NO SURFACE MARRING.** Setting tool won't slip and mar polished or finely finished surface. No dents, dimpling, or wrench marks.

**EXCEPTIONAL VERSATILITY.** Blind rivets hold securely in thin or thick, soft or hard materials, ideal for dissimilar materials. First choice for plastics and other easily damaged components.

**HIGH GRIP AND PULL-UP STRENGTHS.** Ideal for public transportation and other public facilities where tampering and vandalism are problems. Excellent for fastening limited-access panels: authorized personnel with correct equipment easily drill out blind rivets and replace in seconds.

**INCREASED DESIGN FLEXIBILITY.** Setting without need for access at back, minimum backup space requirements, versatility, and neat appearance are just a few of the blind rivet attributes that contribute to design flexibility and improve the quality of the finished product.

**Blind Rivet**



**Applications**



**Aerospace Industry**

**Automotive Industry**

**Building Construction**

**Electrical Electronics Industry**

**Medical Instruments**

## Selecting Correct Type of Blind Rivet

1. The shear and tensile strength of the rivet selected and the number of rivets used in the application should equal or exceed the joint strength requirements. Testing is recommended before final selection and use in product.
2. The rivet body material should be compatible with the materials to be joined to resist galvanic corrosion which may result in reduction of joint strength. If dissimilar materials are widely separated on the galvanic chart, it is advisable to separate them with a dielectric material such as paint or other coating.
3. After determination of strength required by diameter and alloy, the total thickness of materials to be joined must be considered. Select the Rivet grip range which included the total thickness of the material to be joined.
4. Recommended hole sizes listed for each rivet diameter should be followed closely. An under size hole will not allow insertion of the rivet body; an oversize hole will reduce shear and tensile strengths, and may cause improper rivet setting, all of which promote joint failure.
5. The various head styles are offered to accommodate different assembly needs. The most popular is the button head, whose lower profile head is approx. Twice the diameter of the rivet body. This provided adequate bearing surface for nearly all applications. The large flange head rivet provides greater bearing surface for fastening soft or brittle facing materials. The countersunk head rivet is for electric or electronic applications.
6. Besides the sizes, alloys and head styles listed, State Engineering Works manufactures a wide range of special rivets to accommodate a variety of customer needs for strength, head style and grip range.

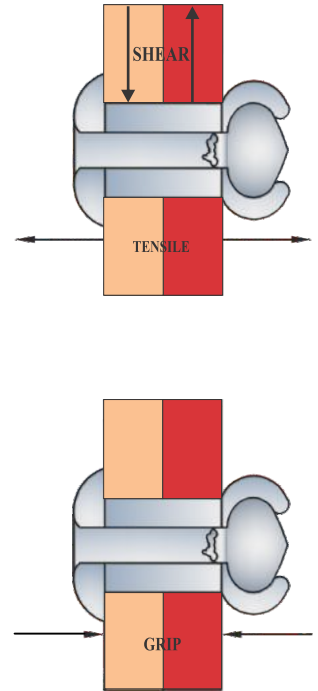

## Blind Rivet Nomenclature

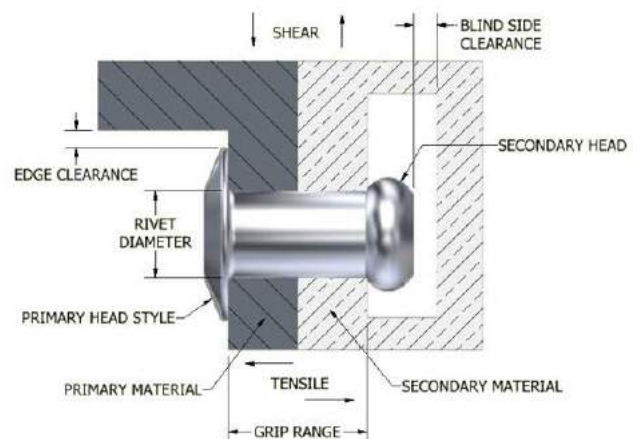
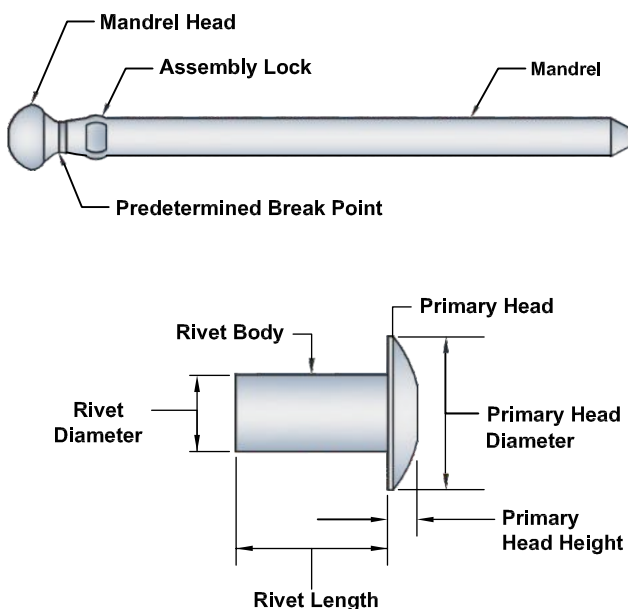



### State Enterprises Breakstem Systems - non structural

This Guide contains a collection of breakstem rivets suited for a wide range of general engineering application. For highly stressed or dynamically loaded applications please refer to the Structural Product Guide. This selection guide is designed to help show you which fasteners may be the most suitable for your application. An State Enterprises Application Engineer is available to answer any question you may have. This guide does not include the full range of State Enterprises products and for more information on specialist products please see the appropriate brochure or our website [www.rivetsindia.com](http://www.rivetsindia.com). Our design department is able to create variation on all our products to suit your individual needs quickly and efficiently.

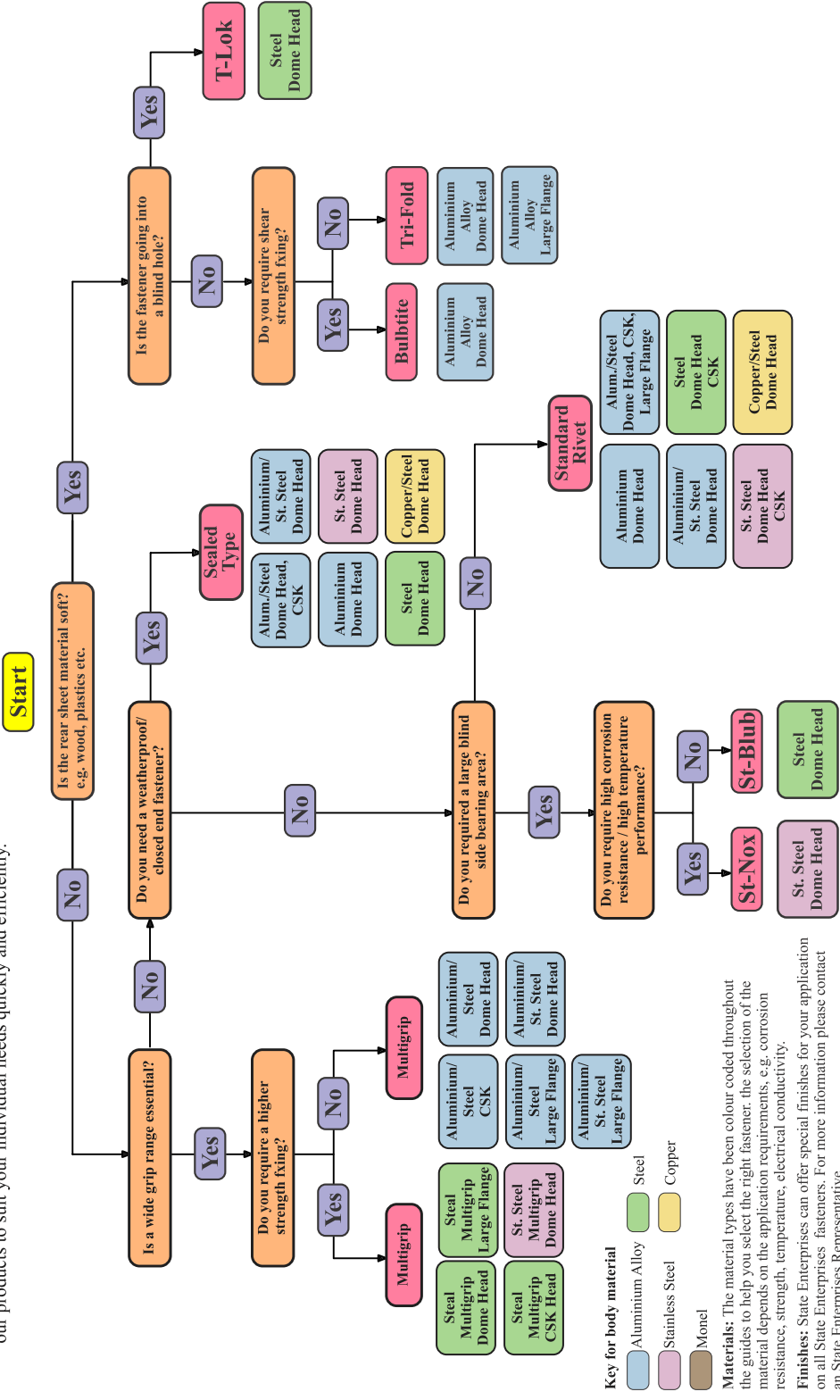

# State Enterprises Trouble Shooting Guide

Description of Typical Potential

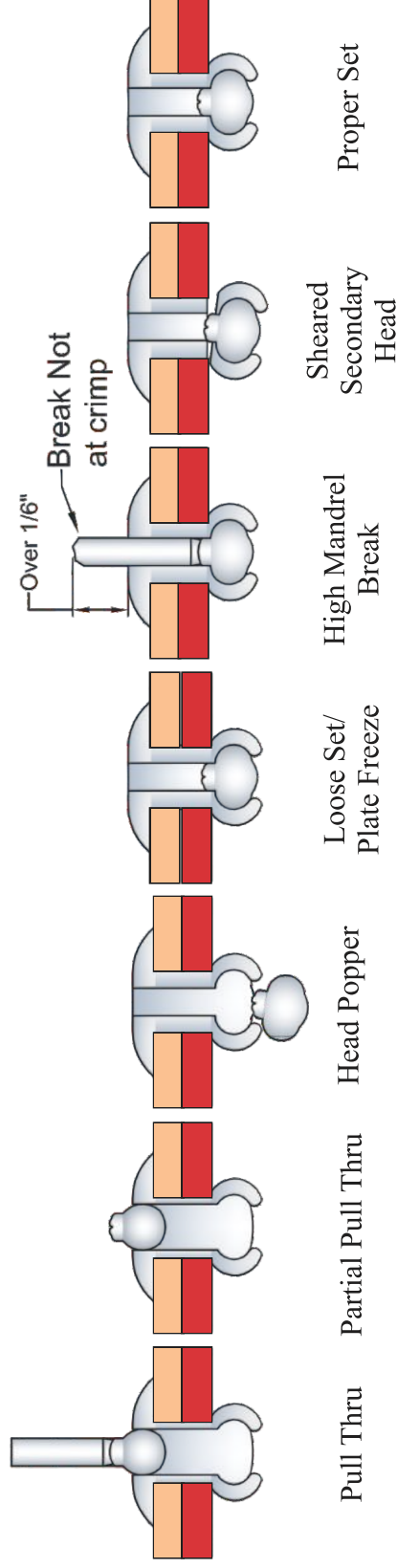

Potential Cause	Problem Type						
	Pull Thru	Partial Pull Thru	Head Popper	Loose Set	Plate Freeze	High Mandrel Break	Sheared Secondary Head
Over maximum recommended hole	★		●	●	●	●	●
Under minimum recommended hole	●	●	★	★	●	★	★
Grip Thickness over minimum	●	●	★	★	●	●	★
Grip Thickness under minimum	★	●	●	★	●	★	●
<b>Improper Hole Condition</b>							
Excessive variation in size	★		★	★	●	★	★
Noncircular hole	★	★	★	★	●	●	★
Tapered hole	★	★	★	★	●	●	★
Burrs and sharp edges	★	★	★	★	●	●	★
Applicable material too soft	★	★	★	●	●	●	●
Non-perpendicular set (improper alignment of tooling to application)	★	★	★	★	★	★	★
Wrong nonspiece on tooling	★	★	●	★	●	●	●
Gap between material thickness	★	★	★	★	★	●	●
Insufficient secondary side clearance	●	●	●	★	★	●	●

★ = APPLICABLE

● = NOT APPLICABLE

## Coloured Blind Rivet



Blind rivets are also available in colour to match the application. To guarantee the best possible durability the hollow rivets are painted using a two-component epoxy resin paint in a stow enamelling process. In addition to the visual benefits, the painted blind rivet also has added protection against corrosion. Aluminium blind rivets are best suited for this procedure. In the long-term they achieve the desired visual effect when joining coloured parts. Blind rivets are available in the standard RAL colours. On request, steel blind rivets are also available in RAL colours or even special colours.

Another method for colouring blind rivets and for protecting them against corrosion is to anodize them. Blind rivets are anodized in a direct current sulphuric acid process. The term Eloxal is used to describe the electrolytic oxidation of aluminium. Eloxal itself is actually colourless. Applying a second coat using metal salts creates the desired light-fast colour. The Eloxal method is more complex but is the most durable process for coloured blind rivets.

Open Type Blind Rivet

Material	
1	Rivet Body - Aluminium 1100 Mandrel - Steel
2	Rivet Body - Aluminium 5050 Mandrel - Steel
3	Rivet Body - Aluminium 5052 Mandrel - Steel
4	Rivet Body - Aluminium 5154 Mandrel - Steel
5	Rivet Body - Aluminium 5056 Mandrel - Steel
6	Rivet Body - Aluminium 5052 Mandrel - Steel
7	Rivet Body - Steel Mandrel - Steel
8	Rivet Body - Stainless Steel Mandrel - Stainless Steel
9	Rivet Body - Copper Mandrel - Steel

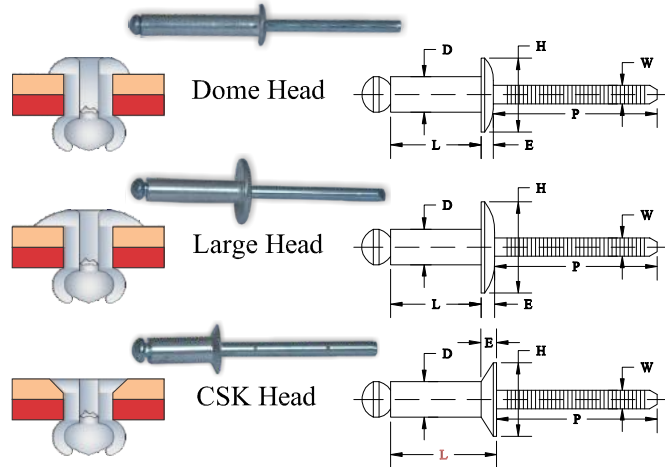

Key Features	
1	Available in a range of sizes and materials.
2	Versatile for general fastening needs.
3	Strong, low cost fastenings.
4	Ideal for wide range of applications.

Open Type Blind Rivet																				
Nom Rivet Size (Inch)		Nom Rivet Size (mm)		Rivet Code	Hole Dia		Domed Head Dia		Head Height	Large Head Dia		Head Height	CSK 120°±2° Head Dia		Head Height	Mandrel Dia	Mandrel Protrusion	Domed Head Grip Range	CSK Head Grip Range	
D	L	D	L		Min.	Max.	Min.	Max.	E	Min.	Max.	E	Min.	Max.	E	W	P	Min.	Max.	Min.
3/32	3/16	2.4	4.8	3-1	2.5-2.6	4.5	5.0	0.8	6.8	7.4	1.0	4.0	4.7	0.7	1.4	27.0	0.5 ~ 1.0	0.5 ~ 1.0		
	1/4		6.4	3-2	2.5-2.6	4.5	5.0	0.8	6.8	7.4	1.0	4.0	4.7	0.7	1.4	27.0	0.5 ~ 1.6	0.5 ~ 1.6		
	5/16		8.0	3-3	2.5-2.6	4.5	5.0	0.8	6.8	7.4	1.0	4.0	4.7	0.7	1.4	27.0	1.6 ~ 3.2	1.6 ~ 3.2		
	3/8		9.6	3-4	2.5-2.6	4.5	5.0	0.8	6.8	7.4	1.0	4.0	4.7	0.7	1.4	27.0	3.2 ~ 4.8	3.2 ~ 4.8		
	1/2		12.7	3-5	2.5-2.6	4.5	5.0	0.8	6.8	7.4	1.0	4.0	4.7	0.7	1.4	27.0	4.8 ~ 6.4	4.8 ~ 6.4		
1/8	5/8	3.2	15.9	3-6	2.5-2.6	4.5	5.0	0.8	6.8	7.4	1.0	4.0	4.7	0.7	1.4	27.0	6.4 ~ 9.6	6.4 ~ 9.6		
	1/4		6.4	4-1	3.3-3.4	6.0	6.6	1.0	9.1	9.9	1.6	5.3	5.9	0.8	1.9	27.0	0.5 ~ 1.6	0.5 ~ 1.6		
	5/16		8.0	4-2	3.3-3.4	6.0	6.6	1.0	9.1	9.9	1.6	5.3	5.9	0.8	1.9	27.0	1.6 ~ 3.2	1.6 ~ 3.2		
	3/8		9.6	4-3	3.3-3.4	6.0	6.6	1.0	9.1	9.9	1.6	5.3	5.9	0.8	1.9	27.0	3.2 ~ 4.8	3.2 ~ 4.8		
	1/2		12.7	4-4	3.3-3.4	6.0	6.6	1.0	9.1	9.9	1.6	5.3	5.9	0.8	1.9	27.0	4.8 ~ 6.4	4.8 ~ 6.4		
	5/8		15.9	4-5	3.3-3.4	6.0	6.6	1.0	9.1	9.9	1.6	5.3	5.9	0.8	1.9	27.0	6.4 ~ 9.6	6.4 ~ 9.6		
5/32	3/4	4.0	19.3	4-6	3.3-3.4	6.0	6.6	1.0	9.1	9.9	1.6	5.3	5.9	0.8	1.9	27.0	9.6 ~ 12.7	9.6 ~ 12.7		
	1.0		25.4	4-7	3.3-3.4	6.0	6.6	1.0	9.1	9.9	1.6	5.3	5.9	0.8	1.9	27.0	16.0 ~ 19.0	16.0 ~ 19.0		
	1/4		6.4	5-1	4.1-4.2	7.5	8.3	1.27	11.3	12.4	1.9	6.8	7.5	1.0	2.4	27.0	0.5 ~ 1.6	0.5 ~ 1.6		
	5/16		8.0	5-2	4.1-4.2	7.5	8.3	1.27	11.3	12.4	1.9	6.8	7.5	1.0	2.4	27.0	1.6 ~ 3.2	1.6 ~ 3.2		
	3/8		9.6	5-3	4.1-4.2	7.5	8.3	1.27	11.3	12.4	1.9	6.8	7.5	1.0	2.4	27.0	3.2 ~ 4.8	3.2 ~ 4.8		
	1/2		12.7	5-4	4.1-4.2	7.5	8.3	1.27	11.3	12.4	1.9	6.8	7.5	1.0	2.4	27.0	4.8 ~ 6.4	4.8 ~ 6.4		
	5/8		15.9	5-5	4.1-4.2	7.5	8.3	1.27	11.3	12.4	1.9	6.8	7.5	1.0	2.4	27.0	6.4 ~ 9.6	6.4 ~ 9.6		
3/16	3/4	4.8	19.3	5-6	4.1-4.2	7.5	8.3	1.27	11.3	12.4	1.9	6.8	7.5	1.0	2.4	27.0	9.6 ~ 12.7	9.6 ~ 12.7		
	1.0		25.4	5-7	4.1-4.2	7.5	8.3	1.27	11.3	12.4	1.9	6.8	7.5	1.0	2.4	27.0	16.0 ~ 19.0	16.0 ~ 19.0		
	1/4		6.4	6-1	4.9-5.0	9.0	10.0	1.52	15.2	16.5	2.3	8.5	9.2	1.3	2.8	27.0	0.5 ~ 1.6	0.5 ~ 1.6		
	5/16		8.0	6-2	4.9-5.0	9.0	10.0	1.52	15.2	16.5	2.3	8.5	9.2	1.3	2.8	27.0	1.6 ~ 3.2	1.6 ~ 3.2		
	3/8		9.6	6-3	4.9-5.0	9.0	10.0	1.52	15.2	16.5	2.3	8.5	9.2	1.3	2.8	27.0	3.2 ~ 4.8	3.2 ~ 4.8		
	1/2		12.7	6-4	4.9-5.0	9.0	10.0	1.52	15.2	16.5	2.3	8.5	9.2	1.3	2.8	27.0	4.8 ~ 6.4	4.8 ~ 6.4		
	5/8		15.9	6-5	4.9-5.0	9.0	10.0	1.52	15.2	16.5	2.3	8.5	9.2	1.3	2.8	27.0	6.4 ~ 9.6	6.4 ~ 9.6		
	3/4		19.3	6-6	4.9-5.0	9.0	10.0	1.52	15.2	16.5	2.3	8.5	9.2	1.3	2.8	27.0	9.6 ~ 12.7	9.6 ~ 12.7		
	1.0		25.4	6-7	4.9-5.0	9.0	10.0	1.52	15.2	16.5	2.3	8.5	9.2	1.3	2.8	27.0	16.0 ~ 19.0	16.0 ~ 19.0		
	1 1/4		31.8	6-8	4.9-5.0	9.0	10.0	1.52	15.2	16.5	2.3	8.5	9.2	1.3	2.8	27.0	22.4 ~ 25.4	22.4 ~ 25.4		
	1 1/2		38.1	6-9	4.9-5.0	9.0	10.0	1.52	15.2	16.5	2.3	8.5	9.2	1.3	2.8	27.0	28.6 ~ 31.8	28.6 ~ 31.8		
1/4	2.0	6.4	50.8	6-10	4.9-5.0	9.0	10.0	1.52	15.2	16.5	2.3	8.5	9.2	1.3	2.8	27.0	31.8 ~ 35.0	31.8 ~ 35.0		
	3/8		9.6	7-1	6.5-6.6	12.0	13.3	2.0	18.2	19.8	2.7	11.6	12.3	1.5	3.8	31.7	3.2 ~ 4.8	3.2 ~ 4.8		
	1/2		12.7	7-2	6.5-6.6	12.0	13.3	2.0	18.2	19.8	2.7	11.6	12.3	1.5	3.8	31.7	4.8 ~ 6.4	4.8 ~ 6.4		
	5/8		15.9	7-3	6.5-6.6	12.0	13.3	2.0	18.2	19.8	2.7	11.6	12.3	1.5	3.8	31.7	6.4 ~ 9.6	6.4 ~ 9.6		
	3/4		19.3	7-4	6.5-6.6	12.0	13.3	2.0	18.2	19.8	2.7	11.6	12.3	1.5	3.8	31.7	9.6 ~ 12.7	9.6 ~ 12.7		
1.0	25.4	7-5	6.5-6.6	12.0	13.3	2.0	18.2	19.8	2.7	11.6	12.3	1.5	3.8	31.7	16.0 ~ 19.0	16.0 ~ 19.0				

Open Type Blind Rivet

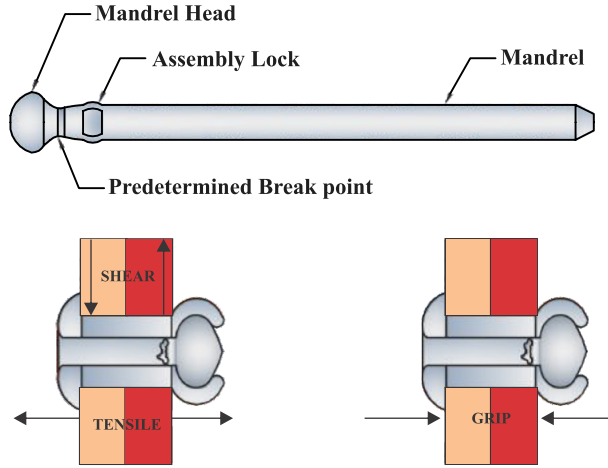

Material Rivet Body - Aluminium 1100 Mandrel - Steel									Material Rivet Body - Aluminium 5050 Mandrel - Steel									Material Rivet Body - Aluminium 5052 Mandrel - Steel								
Rivet Size		Tensile (Min.)		Shear (Min.)		Mandrel Break Load			Rivet Size		Tensile (Min.)		Shear (Min.)		Mandrel Break Load			Rivet Size		Tensile (Min.)		Shear (Min.)		Mandrel Break Load		
(mm)	(inch)	N	LBS	N	LBS		N	LBS	(mm)	(inch)	N	LBS	N	LBS		N	LBS	(mm)	(inch)	N	LBS	N	LBS		N	LBS
2.4	3/32	-	-	-	-	Min.	-	-	2.4	3/32	258	58	172	39	Min.	778	175	2.4	3/32	360	80	310	70	Min.	778	175
						Max.	-	-						Max.	1223	275							Max.	1223	275	
3.2	1/8	334	75	222	50	Min.	1334	300	3.2	1/8	450	100	360	81	Min.	1780	400	3.2	1/8	670	150	530	120	Min.	1780	400
						Max.	2224	500							Max.	2668	600						Max.	2668	600	
4.0	5/32	578	130	400	90	Min.	2224	500	4.0	5/32	750	168	540	120	Min.	2668	600	4.0	5/32	1020	230	850	190	Min.	2668	600
						Max.	3114	700							Max.	3780	850						Max.	3780	850	
4.8	3/16	845	190	578	130	Min.	2669	600	4.8	3/16	1050	235	935	210	Min.	3336	750	4.8	3/16	1430	320	1160	260	Min.	3336	750
						Max.	3559	800							Max.	4670	1050						Max.	4670	1050	
6.4	1/4	-	-	-	-	Min.	-	-	6.4	1/4	2050	460	1460	328	Min.	6450	1450	6.4	1/4	2500	560	2050	460	Min.	6450	1450
						Max.	-	-							Max.	8229	1850						Max.	8229	1850	
Material Rivet Body - Aluminium 5154 Mandrel - Steel									Material Rivet Body - Aluminium 5056 Mandrel - Steel									Material Rivet Body - Aluminium 5052 Mandrel - Stainless Steel								
Rivet Size		Tensile (Min.)		Shear (Min.)		Mandrel Break Load			Rivet Size		Tensile (Min.)		Shear (Min.)		Mandrel Break Load			Rivet Size		Tensile (Min.)		Shear (Min.)		Mandrel Break Load		
(mm)	(inch)	N	LBS	N	LBS		N	LBS	(mm)	(inch)	N	LBS	N	LBS		N	LBS	(mm)	(inch)	N	LBS	N	LBS		N	LBS
2.4	3/32	535	120	400	90	Min.	778	175	2.4	3/32	535	120	400	90	Min.	778	175	2.4	3/32	-	-	-	-	Min.	-	-
						Max.	1223	275							Max.	1223	275							Max.	-	-
3.2	1/8	980	220	760	170	Min.	1780	400	3.2	1/8	980	220	760	170	Min.	1780	400	3.2	1/8	934	210	689	155	Min.	2269	510
						Max.	2668	600							Max.	2668	600						Max.	2669	600	
4.0	5/32	1560	350	1160	260	Min.	2668	600	4.0	5/32	1560	350	1160	260	Min.	2668	600	4.0	5/32	1512	340	1157	260	Min.	3203	720
						Max.	3780	850							Max.	3780	850						Max.	3781	850	
4.8	3/16	2230	500	1700	380	Min.	3336	750	4.8	3/16	2230	500	1700	380	Min.	3336	750	4.8	3/16	2068	465	1334	300	Min.	4626	1040
						Max.	4670	1050							Max.	4670	1050						Max.	5382	1210	
6.4	1/4	4100	920	3120	700	Min.	6450	1450	6.4	1/4	4100	920	3120	700	Min.	6450	1450	6.4	1/4	-	-	-	-	Min.	-	-
						Max.	8229	1850							Max.	8229	1850						Max.	-	-	
Material Rivet Body - Steel Mandrel - Steel									Material Rivet Body - Stainless Steel Mandrel - Stainless Steel									Material Rivet Body - Copper Mandrel - Steel								
Rivet Size		Tensile (Min.)		Shear (Min.)		Mandrel Break Load			Rivet Size		Tensile (Min.)		Shear (Min.)		Mandrel Break Load			Rivet Size		Tensile (Min.)		Shear (Min.)		Mandrel Break Load		
(mm)	(inch)	N	LBS	N	LBS		N	LBS	(mm)	(inch)	N	LBS	N	LBS		N	LBS	(mm)	(inch)	N	LBS	N	LBS		N	LBS
3.2	1/8	1380	310	1160	260	Min.	2668	600	3.2	1/8	2360	530	1870	420	Min.	2891	650	3.2	1/8	800	180	700	157	Min.	1780	400
						Max.	3558	800							Max.	4225	950						Max.	2668	600	
4.0	5/32	2100	470	1650	370	Min.	3336	750	4.0	5/32	3650	820	2990	650	Min.	5115	1150	4.0	5/32	1500	337	1000	225	Min.	2668	600
						Max.	4448	1000							Max.	6450	1450						Max.	3780	850	
4.8	3/16	3030	680	2400	540	Min.	5115	1150	4.8	3/16	5340	1200	4230	950	Min.	6227	1400	4.8	3/16	2000	450	1500	337	Min.	3336	750
						Max.	6450	1450							Max.	8451	1900						Max.	4670	1050	
6.4	1/4	5520	1240	4450	1000	Min.	8674	1950	6.4	1/4	9350	2100	7570	1700	Min.	13344	3000	6.4	1/4	-	-	-	-	Min.	6450	1450
						Max.	10435	2350							Max.	16013	3600						Max.	8229	1850	

Close Type Blind Rivet

Material	
1	Rivet Body - Aluminium 1100 Mandrel - Aluminium Alloy
2	Rivet Body - Aluminium 5056 Mandrel - Steel
3	Rivet Body - Aluminium 5056 Mandrel - Stainless Steel
4	Rivet Body - Steel Mandrel - Steel
5	Rivet Body - Stainless Steel Mandrel - Stainless Steel
6	Rivet Body - Copper Mandrel - Steel

  

Key Features	
1	Seals out moisture, air and other contaminants.
2	Higher tensile and shear strength than the equivalent open end rivet.
3	100% mandrel head retention guaranteed.

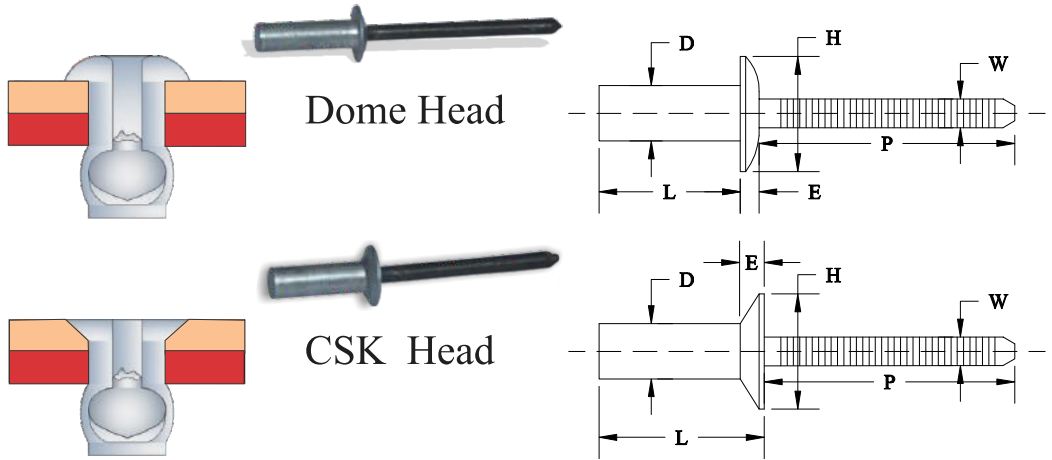

Close Type Blind Rivet															
Nom Rivet Size (Inch)		Nom Rivet Size (mm)		Rivet Code	Hole Dia	Domed Head Dia		Head Height	CSK 120°±2° Head Dia		CSK 120°±2° Head Height	Mandrel Dia	Mandrel Protrusion	Domed Head Grip Range	CSK Head Grip Range
D	L	D	L			H		E	H		E	W	P	Min.~ Max.	Min.~ Max.
-0.2	Max.	-0.2	Max.		Min.~ Max.	Min.	Max.	Max.	Min.	Max.	Max.	Max.	Min.	Min.~ Max.	Min.~ Max.
1/8	1/4	3.2	6.4	4-1	3.28 ~ 3.38	5.69	6.40	1.27	5.61	6.22	1.07	1.85	25.0	0.5 ~ 1.0	0.5 ~ 1.0
	5/16		8.0	4-2	3.28 ~ 3.38	5.69	6.40	1.27	5.61	6.22	1.07	1.85	25.0	1.1 ~ 2.1	1.1 ~ 2.1
	3/8		9.6	4-3	3.28 ~ 3.38	5.69	6.40	1.27	5.61	6.22	1.07	1.85	25.0	2.1 ~ 3.2	2.1 ~ 3.2
	7/16		11.1	4-4	3.28 ~ 3.38	5.69	6.40	1.27	5.61	6.22	1.07	1.85	25.0	3.3 ~ 4.8	3.3 ~ 4.8
	1/2		12.7	4-5	3.28 ~ 3.38	5.69	6.40	1.27	5.61	6.22	1.07	1.85	25.0	4.9 ~ 6.4	4.9 ~ 6.4
	9/16		14.3	4-6	3.28 ~ 3.38	5.69	6.40	1.27	5.61	6.22	1.07	1.85	25.0	6.5 ~ 7.9	6.5 ~ 7.9
	5/8		15.9	4-7	3.28 ~ 3.38	5.69	6.40	1.27	5.61	6.22	1.07	1.85	25.0	8.0 ~ 9.5	8.0 ~ 9.5
	11/16		17.7	4-8	3.28 ~ 3.38	5.69	6.40	1.27	5.61	6.22	1.07	1.85	25.0	9.6 ~ 11.1	9.6 ~ 11.1
5/32	3/4	4.0	19.0	4-9	3.28 ~ 3.38	5.69	6.40	1.27	5.61	6.22	1.07	1.85	25.0	11.2 ~ 12.7	11.2 ~ 12.7
	1/4		6.4	5-1	4.06 ~ 4.16	7.52	8.33	1.65	7.52	8.33	1.30	2.31	27.0	0.5 ~ 1.0	0.5 ~ 1.0
	5/16		8.0	5-2	4.06 ~ 4.16	7.52	8.33	1.65	7.52	8.33	1.30	2.31	27.0	1.1 ~ 2.1	1.1 ~ 2.1
	3/8		9.6	5-3	4.06 ~ 4.16	7.52	8.33	1.65	7.52	8.33	1.30	2.31	27.0	2.1 ~ 3.2	2.1 ~ 3.2
	7/16		11.1	5-4	4.06 ~ 4.16	7.52	8.33	1.65	7.52	8.33	1.30	2.31	27.0	3.3 ~ 4.8	3.3 ~ 4.8
	1/2		12.7	5-5	4.06 ~ 4.16	7.52	8.33	1.65	7.52	8.33	1.30	2.31	27.0	4.9 ~ 6.4	4.9 ~ 6.4
	9/16		14.3	5-6	4.06 ~ 4.16	7.52	8.33	1.65	7.52	8.33	1.30	2.31	27.0	6.5 ~ 7.9	6.5 ~ 7.9
	5/8		15.9	5-7	4.06 ~ 4.16	7.52	8.33	1.65	7.52	8.33	1.30	2.31	27.0	8.0 ~ 9.5	8.0 ~ 9.5
3/16	11/16	4.8	17.7	5-8	4.06 ~ 4.16	7.52	8.33	1.65	7.52	8.33	1.30	2.31	27.0	9.6 ~ 11.1	9.6 ~ 11.1
	3/4		19.0	5-9	4.06 ~ 4.16	7.52	8.33	1.65	7.52	8.33	1.30	2.31	27.0	11.2 ~ 12.7	11.2 ~ 12.7
	5/16		8.0	6-1	4.88 ~ 4.98	9.04	10.01	2.03	9.04	10.01	1.50	2.77	27.0	1.1 ~ 2.1	1.1 ~ 2.1
	3/8		9.6	6-2	4.88 ~ 4.98	9.04	10.01	2.03	9.04	10.01	1.50	2.77	27.0	2.1 ~ 3.2	2.1 ~ 3.2
	7/16		11.1	6-3	4.88 ~ 4.98	9.04	10.01	2.03	9.04	10.01	1.50	2.77	27.0	3.3 ~ 4.8	3.3 ~ 4.8
	1/2		12.7	6-4	4.88 ~ 4.98	9.04	10.01	2.03	9.04	10.01	1.50	2.77	27.0	4.9 ~ 6.4	4.9 ~ 6.4
	9/16		14.3	6-5	4.88 ~ 4.98	9.04	10.01	2.03	9.04	10.01	1.50	2.77	27.0	6.5 ~ 7.9	6.5 ~ 7.9
	5/8		15.9	6-6	4.88 ~ 4.98	9.04	10.01	2.03	9.04	10.01	1.50	2.77	27.0	8.0 ~ 9.5	8.0 ~ 9.5
1/4	11/16	6.4	17.7	6-7	4.88 ~ 4.98	9.04	10.01	2.03	9.04	10.01	1.50	2.77	27.0	9.6 ~ 11.1	9.6 ~ 11.1
	3/4		19.0	6-8	4.88 ~ 4.98	9.04	10.01	2.03	9.04	10.01	1.50	2.77	27.0	11.2 ~ 12.7	11.2 ~ 12.7
	7/8		22.1	6-9	4.88 ~ 4.98	9.04	10.01	2.03	9.04	10.01	1.50	2.77	27.0	12.8 ~ 15.9	12.8 ~ 15.9
	1.0		25.4	6-10	4.88 ~ 4.98	9.04	10.01	2.03	9.04	10.01	1.50	2.77	27.0	16.0 ~ 19.1	16.0 ~ 19.1
	3/8		9.6	7-1	6.53 ~ 6.63	12.07	13.33	2.54	12.07	13.33	2.00	3.71	27.0	2.1 ~ 3.2	2.1 ~ 3.2
	7/16		11.1	7-2	6.53 ~ 6.63	12.07	13.33	2.54	12.07	13.33	2.00	3.71	27.0	3.3 ~ 4.8	3.3 ~ 4.8
	1/2		12.7	7-3	6.53 ~ 6.63	12.07	13.33	2.54	12.07	13.33	2.00	3.71	27.0	4.9 ~ 6.4	4.9 ~ 6.4
	9/16		14.3	7-4	6.53 ~ 6.63	12.07	13.33	2.54	12.07	13.33	2.00	3.71	27.0	6.5 ~ 7.9	6.5 ~ 7.9
1/4	5/8	6.4	15.9	7-5	6.53 ~ 6.63	12.07	13.33	2.54	12.07	13.33	2.00	3.71	27.0	8.0 ~ 9.5	8.0 ~ 9.5
	11/16		17.7	7-6	6.53 ~ 6.63	12.07	13.33	2.54	12.07	13.33	2.00	3.71	27.0	9.6 ~ 11.1	9.6 ~ 11.1
	3/4		19.0	7-7	6.53 ~ 6.63	12.07	13.33	2.54	12.07	13.33	2.00	3.71	27.0	11.2 ~ 12.7	11.2 ~ 12.7
	7/8		22.1	7-8	6.53 ~ 6.63	12.07	13.33	2.54	12.07	13.33	2.00	3.71	27.0	12.8 ~ 15.9	12.8 ~ 15.9
	1.0		25.4	7-9	6.53 ~ 6.63	12.07	13.33	2.54	12.07	13.33	2.00	3.71	27.0	16.0 ~ 19.1	16.0 ~ 19.1

Close Type Blind Rivet

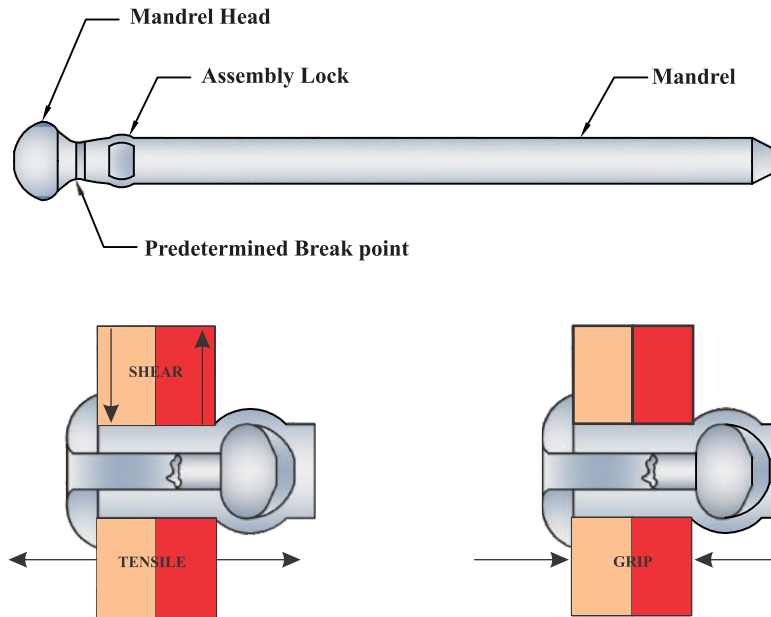

Material		Rivet Body - Aluminium 1100 Mandrel - Aluminium Alloy						Material		Rivet Body - Aluminium 5056 Mandrel - Steel						Material		Rivet Body - Aluminium 5056 Mandrel - Stainless Steel											
Rivet Size		Tensile (Min.)		Shear (Min.)		Mandrel Break Load		Rivet Size		Tensile (Min.)		Shear (Min.)		Mandrel Break Load		Rivet Size		Tensile (Min.)		Shear (Min.)		Mandrel Break Load							
(mm)	(inch)	N	LBS	N	LBS	Min.	N	LBS	(mm)	(inch)	N	LBS	N	LBS	Min.	N	LBS	(mm)	(inch)	N	LBS	N	LBS	Min.	N	LBS			
3.2	1/8	490	110	445	100	Min. 1112	250	Max. 1780	400	3.2	1/8	1250	280	1070	240	Min. 2446	550	Max. 3336	750	3.2	1/8	1250	280	1070	240	Min. 2446	550	Max. 3336	750
4.0	5/32	715	160	580	130	Min. 1890	425	Max. 2668	600	4.0	5/32	2140	480	1560	350	Min. 3113	700	Max. 4893	1100	4.0	5/32	2140	480	1560	350	Min. 3113	700	Max. 4893	1100
4.8	3/16	1115	250	935	210	Min. 2668	600	Max. 3558	800	4.8	3/16	3070	690	2230	500	Min. 4003	900	Max. 6338	1425	4.8	3/16	3070	690	2230	500	Min. 4003	900	Max. 6338	1425
6.4	1/4	-	-	-	-	Min. -	-	Max. -	-	6.4	1/4	4890	1100	4000	900	Min. 8451	1900	Max. 10230	2300	6.4	1/4	4890	1100	4000	900	Min. 8451	1900	Max. 10230	2300
Material		Rivet Body - Steel Mandrel - Steel						Material		Rivet Body - Stainless Steel Mandrel - Stainless Steel						Material		Rivet Body - Copper Mandrel - Steel											
Rivet Size		Tensile (Min.)		Shear (Min.)		Mandrel Break Load		Rivet Size		Tensile (Min.)		Shear (Min.)		Mandrel Break Load		Rivet Size		Tensile (Min.)		Shear (Min.)		Mandrel Break Load							
(mm)	(inch)	N	LBS	N	LBS	Min.	N	LBS	(mm)	(inch)	N	LBS	N	LBS	Min.	N	LBS	(mm)	(inch)	N	LBS	N	LBS	Min.	N	LBS			
3.2	1/8	1300	292	1150	258	Min. 2668	600	Max. 3558	800	3.2	1/8	2000	450	1780	400	Min. 2780	625	Max. 4225	950	3.2	1/8	1340	300	980	220	Min. 2446	550	Max. 3336	750
4.0	5/32	1860	418	1700	380	Min. 4225	950	Max. 5450	1225	4.0	5/32	3560	800	3120	700	Min. 4337	975	Max. 6227	1400	4.0	5/32	2000	450	1350	305	Min. 3780	850	Max. 4893	1100
4.8	3/16	2800	630	2400	540	Min. 7117	1600	Max. 9786	2200	4.8	3/16	4010	900	3790	850	Min. 7228	1625	Max. 8340	1875	4.8	3/16	2800	630	1950	438	Min. 5337	1200	Max. 6672	1500
6.4	1/4	4000	900	3600	810	Min. -	-	Max. -	-	6.4	1/4	8000	1797	6000	1348	Min. -	-	Max. -	-	6.4	1/4	-	-	-	-	Min. -	-	Max. -	-

Multigrip Rivet

Material	
1	Rivet Body - Aluminium 5050 Mandrel - Steel
2	Rivet Body - Aluminium 5052 Mandrel - Steel

Key Features	
1	Multi-grip capability
2	Good hole fill
3	Retained stem
4	Large blind side bearing area

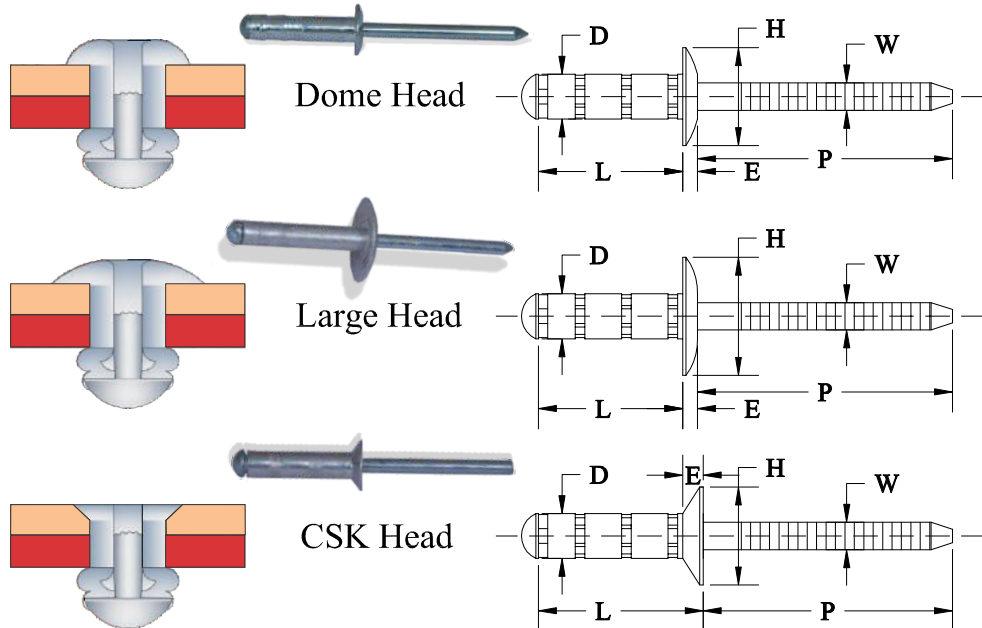

Multigrip Rivet Aluminium																			
Nom Rivet Size (Inch)		Nom Rivet Size (mm)		Rivet Code	Hole Dia		Domed Head Dia		Head Height	Large Head Dia		Head Height	CSK 120°±2° Head Dia		Head Height	Mandrel Dia	Mandrel Protrusion	Domed Head Grip Range	CSK 120° Head
D	L	D	L		Min.~Max.	Min.	Max.	Max.	Min.	Max.	Max.	Min.	Max.	Max.	Min.	Max.	Nom	Min.	Min.~Max.
3/32	3/16	2.4	4.8	3-1	2.5~2.6	4.5	5.0	0.8	6.8	7.4	1.0	4.0	4.7	0.7	1.4	27.0	0.5~1.0	0.5~1.0	
	1/4		6.4	3-2	2.5~2.6	4.5	5.0	0.8	6.8	7.4	1.0	4.0	4.7	0.7	1.4	27.0	0.5~1.6	0.5~1.6	
	5/16		8.0	3-3	2.5~2.6	4.5	5.0	0.8	6.8	7.4	1.0	4.0	4.7	0.7	1.4	27.0	1.6~3.2	1.6~3.2	
	3/8		9.6	3-4	2.5~2.6	4.5	5.0	0.8	6.8	7.4	1.0	4.0	4.7	0.7	1.4	27.0	3.2~4.8	3.2~4.8	
	1/2		12.7	3-5	2.5~2.6	4.5	5.0	0.8	6.8	7.4	1.0	4.0	4.7	0.7	1.4	27.0	4.8~6.4	4.8~6.4	
1/8	5/8	3.2	15.9	3-6	2.5~2.6	4.5	5.0	0.8	6.8	7.4	1.0	4.0	4.7	0.7	1.4	27.0	6.4~9.6	6.4~9.6	
	1/4		6.4	4-1	3.3~3.4	6.0	6.6	1.0	9.1	9.9	1.6	5.3	5.9	0.8	1.9	27.0	0.5~1.6	0.5~1.6	
	5/16		8.0	4-2	3.3~3.4	6.0	6.6	1.0	9.1	9.9	1.6	5.3	5.9	0.8	1.9	27.0	1.6~3.2	1.6~3.2	
	3/8		9.6	4-3	3.3~3.4	6.0	6.6	1.0	9.1	9.9	1.6	5.3	5.9	0.8	1.9	27.0	3.2~4.8	3.2~4.8	
	1/2		12.7	4-4	3.3~3.4	6.0	6.6	1.0	9.1	9.9	1.6	5.3	5.9	0.8	1.9	27.0	4.8~6.4	4.8~6.4	
	5/8		15.9	4-5	3.3~3.4	6.0	6.6	1.0	9.1	9.9	1.6	5.3	5.9	0.8	1.9	27.0	6.4~9.6	6.4~9.6	
5/32	3/4	4.0	19.3	4-6	3.3~3.4	6.0	6.6	1.0	9.1	9.9	1.6	5.3	5.9	0.8	1.9	27.0	9.6~12.7	9.6~12.7	
	1.0		25.4	4-7	3.3~3.4	6.0	6.6	1.0	9.1	9.9	1.6	5.3	5.9	0.8	1.9	27.0	16.0~19.0	16.0~19.0	
	1/4		6.4	5-1	4.1~4.2	7.5	8.3	1.27	11.3	12.4	1.9	6.8	7.5	1.0	2.4	27.0	0.5~1.6	0.5~1.6	
	5/16		8.0	5-2	4.1~4.2	7.5	8.3	1.27	11.3	12.4	1.9	6.8	7.5	1.0	2.4	27.0	1.6~3.2	1.6~3.2	
	3/8		9.6	5-3	4.1~4.2	7.5	8.3	1.27	11.3	12.4	1.9	6.8	7.5	1.0	2.4	27.0	3.2~4.8	3.2~4.8	
	1/2		12.7	5-4	4.1~4.2	7.5	8.3	1.27	11.3	12.4	1.9	6.8	7.5	1.0	2.4	27.0	4.8~6.4	4.8~6.4	
	5/8		15.9	5-5	4.1~4.2	7.5	8.3	1.27	11.3	12.4	1.9	6.8	7.5	1.0	2.4	27.0	6.4~9.6	6.4~9.6	
3/16	3/4	4.8	19.3	5-6	4.1~4.2	7.5	8.3	1.27	11.3	12.4	1.9	6.8	7.5	1.0	2.4	27.0	9.6~12.7	9.6~12.7	
	1.0		25.4	5-7	4.1~4.2	7.5	8.3	1.27	11.3	12.4	1.9	6.8	7.5	1.0	2.4	27.0	16.0~19.0	16.0~19.0	
	1/4		6.4	6-1	4.9~5.0	9.0	10.0	1.52	15.2	16.5	2.3	8.5	9.2	1.3	2.8	27.0	0.5~1.6	0.5~1.6	
	5/16		8.0	6-2	4.9~5.0	9.0	10.0	1.52	15.2	16.5	2.3	8.5	9.2	1.3	2.8	27.0	1.6~3.2	1.6~3.2	
	3/8		9.6	6-3	4.9~5.0	9.0	10.0	1.52	15.2	16.5	2.3	8.5	9.2	1.3	2.8	27.0	3.2~4.8	3.2~4.8	
	1/2		12.7	6-4	4.9~5.0	9.0	10.0	1.52	15.2	16.5	2.3	8.5	9.2	1.3	2.8	27.0	4.8~6.4	4.8~6.4	
	5/8		15.9	6-5	4.9~5.0	9.0	10.0	1.52	15.2	16.5	2.3	8.5	9.2	1.3	2.8	27.0	6.4~9.6	6.4~9.6	
	3/4		19.3	6-6	4.9~5.0	9.0	10.0	1.52	15.2	16.5	2.3	8.5	9.2	1.3	2.8	27.0	9.6~12.7	9.6~12.7	
	1.0		25.4	6-7	4.9~5.0	9.0	10.0	1.52	15.2	16.5	2.3	8.5	9.2	1.3	2.8	27.0	16.0~19.0	16.0~19.0	
	1 1/4		31.8	6-8	4.9~5.0	9.0	10.0	1.52	15.2	16.5	2.3	8.5	9.2	1.3	2.8	27.0	22.4~25.4	22.4~25.4	
1/4	1 1/2	6.4	38.1	6-9	4.9~5.0	9.0	10.0	1.52	15.2	16.5	2.3	8.5	9.2	1.3	2.8	27.0	28.6~31.8	28.6~31.8	
	2.0		50.8	6-10	4.9~5.0	9.0	10.0	1.52	15.2	16.5	2.3	8.5	9.2	1.3	2.8	27.0	31.8~35.0	31.8~35.0	
	3/8		9.6	7-1	6.5~6.6	12.0	13.3	2.0	18.2	19.8	2.7	11.6	12.3	1.5	3.8	31.7	3.2~4.8	3.2~4.8	
	1/2		12.7	7-2	6.5~6.6	12.0	13.3	2.0	18.2	19.8	2.7	11.6	12.3	1.5	3.8	31.7	4.8~6.4	4.8~6.4	
	5/8		15.9	7-3	6.5~6.6	12.0	13.3	2.0	18.2	19.8	2.7	11.6	12.3	1.5	3.8	31.7	6.4~9.6	6.4~9.6	
3/4	19.3	7-4	6.5~6.6	12.0	13.3	2.0	18.2	19.8	2.7	11.6	12.3	1.5	3.8	31.7	9.6~12.7	9.6~12.7			
1.0	25.4	7-5	6.5~6.6	12.0	13.3	2.0	18.2	19.8	2.7	11.6	12.3	1.5	3.8	31.7	16.0~19.0	16.0~19.0			



## Multigrip Rivet Aluminium

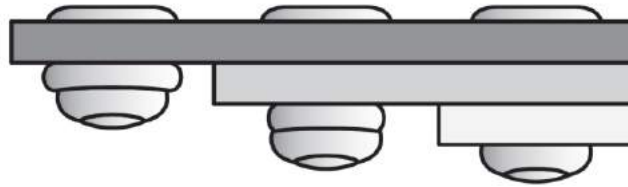

Material		Multigrip Rivet Body - Aluminium 5050 Mandrel - Steel							Material		Multigrip Rivet Body - Aluminium 5052 Mandrel - Steel						
Rivet Size		Tensile (Min.)		Shear (Min.)		Mandrel Break Load			Rivet Size		Tensile (Min.)		Shear (Min.)		Mandrel Break Load		
(mm)	(inch)	N	LBS	N	LBS		N	LBS	(mm)	(inch)	N	LBS	N	LBS		N	LBS
3.2	1/8	667	150	533	120	Min.	1779	400	3.2	1/8	900	202	600	135	Min.	1779	400
						Max.	2446	550							Max.	2446	550
4.0	5/32	1023	230	845	190	Min.	2224	500	4.0	5/32	1500	337	950	213	Min.	2224	500
						Max.	2891	650							Max.	2891	650
4.8	3/16	1423	320	1156	260	Min.	3336	750	4.8	3/16	2000	450	1320	296	Min.	3336	750
						Max.	4003	900							Max.	4003	900

Multigrip Rivet



Material	
1	Rivet Body - Steel Mandrel - Steel
2	Rivet Body - Stainless Steel Mandrel - Stainless Steel

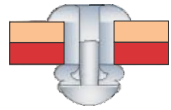

Dome Head

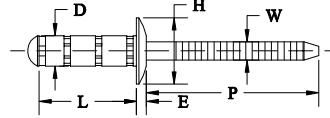

Key Features	
1	Multi-grip capability
2	Good hole fill
3	Retained stem
4	Large blind side bearing area

Multigrip Rivet Dome Head Steel & Stainless Steel

Rivet size (D x L) (mm)	Rivet Code	Hole Dia (mm)	Head Dia (mm)	Head Thickness (mm)	Grip Range (mm)	Mandrel Protrusion (mm)	Rivet Size	Mandrel Dia. (mm)	Mandrel Break	Tensile	Shear		
<b>D-0.15/+0.08 x L ± 0.3</b>		(Min.) ~ (Max.)	(H) ± 0.3	(E) (Max.)	(Min.) ~ (Max.)	(P) (Min.)		(W)	N LBS	N LBS	N LBS		
3.2 x 8.2	4-1	3.3 ~ 3.4	6.35	1.02	1.0 ~ 3.2	27	3.2	2.05 (+0/-0.03)	Multigrip Rivet Body - Steel Mandrel - Steel				
3.2 x 9.9	4-2	3.3 ~ 3.4	6.35	1.02	1.0 ~ 4.8	27			Min. 2668 600	1400	315	1100	250
3.2 x 11.4	4-3	3.3 ~ 3.4	6.35	1.02	1.6 ~ 6.4	27			Max. 3558 800				
3.2 x 13	4-4	3.3 ~ 3.4	6.35	1.02	3.2 ~ 8.0	27	3.2	2.20 (+0.10/-0)	Multigrip Rivet Body - Stainless Steel Mandrel - Stainless Steel				
3.2 x 14.6	4-5	3.3 ~ 3.4	6.35	1.02	4.8 ~ 9.6	27			Min. 3000 675	2000	450	1700	380
3.2 x 16.2	4-6	3.3 ~ 3.4	6.35	1.02	6.4 ~ 11.2	27			Max. 4000 900				
4 x 8.9	5-1	4.1 ~ 4.2	7.95	1.27	1.2 ~ 3.2	27	4.0	2.65 (+0/-0.03)	Multigrip Rivet Body - Steel Mandrel - Steel				
4 x 10.5	5-2	4.1 ~ 4.2	7.95	1.27	1.6 ~ 4.8	27			Min. 4000 900	2100	470	1800	400
4 x 12	5-3	4.1 ~ 4.2	7.95	1.27	1.6 ~ 6.4	27			Max. 5337 1200				
4 x 13.6	5-4	4.1 ~ 4.2	7.95	1.27	3.2 ~ 8.0	27	4.0	2.70 (+0.15/-0)	Multigrip Rivet Body - Stainless Steel Mandrel - Stainless Steel				
4 x 15.2	5-5	4.1 ~ 4.2	7.95	1.27	4.8 ~ 9.6	27			Min. 5300 1190	3200	720	2900	650
4 x 16.8	5-6	4.1 ~ 4.2	7.95	1.27	6.4 ~ 11.2	27			Max. 6300 1415				
4 x 18.4	5-7	4.1 ~ 4.2	7.95	1.27	8.0 ~ 12.7	27							
4.8 x 9.5	6-1	4.9 ~ 5.0	9.50	1.52	1.6 ~ 3.2	27	4.8	3.00 (+0.15/-0)	Multigrip Rivet Body - Steel Mandrel - Steel				
4.8 x 11.1	6-2	4.9 ~ 5.0	9.50	1.52	1.6 ~ 4.8	27			Min. 6000 1350	3100	700	2600	585
4.8 x 12.7	6-3	4.9 ~ 5.0	9.50	1.52	1.6 ~ 6.4	27			Max. 7340 1650				
4.8 x 14.3	6-4	4.9 ~ 5.0	9.50	1.52	3.2 ~ 8.0	27	4.8	3.10 (+0.15/-0)	Multigrip Rivet Body - Stainless Steel Mandrel - Stainless Steel				
4.8 x 15.9	6-5	4.9 ~ 5.0	9.50	1.52	4.8 ~ 9.6	27			Min. 6100 1370	4800	1080	4100	920
4.8 x 17.5	6-6	4.9 ~ 5.0	9.50	1.52	6.4 ~ 11.2	27			Max. 7700 1730				
4.8 x 19.3	6-7	4.9 ~ 5.0	9.50	1.52	8.0 ~ 12.7	27							
4.8 x 20.7	6-8	4.9 ~ 5.0	9.50	1.52	9.6 ~ 14.3	27							
4.8 x 23.8	6-9	4.9 ~ 5.0	9.50	1.52	12.7 ~ 17.5	27							

Steel & Stainless Steel Multigrip Rivets are also available in CSK Head & Large Flange Head on request

## Tri-Fold Blind Rivet

Material	
1	Rivet Body - Aluminium Mandrel - Aluminium

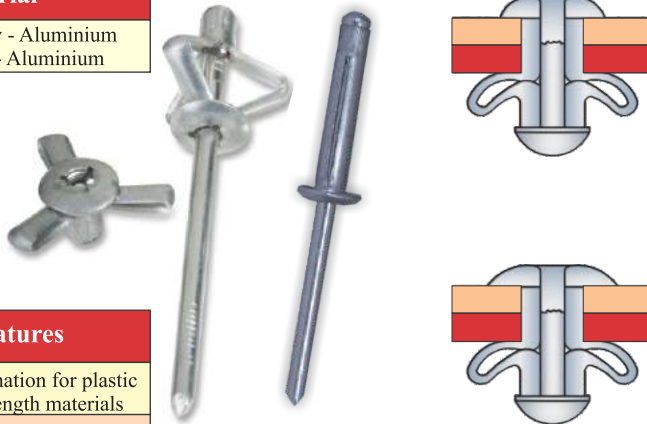

Key Features	
1	Split tail formation for plastic and low strength materials
2	Multi-grip capability
3	Retained stem

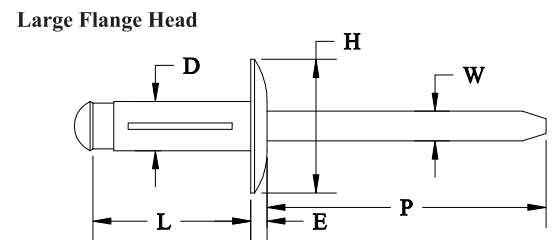
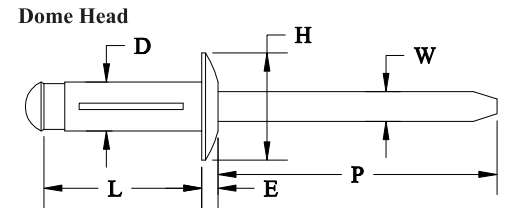

## Tri-Fold Blind Rivet Aluminium

## Dome Head

Rivet size (D x L) (mm)	Rivet Code	Hole Dia (mm)	Head Dia (mm)	Head Thickness	Grip Range (mm)	Mandrel Protrusion	Mandrel Dia. (mm)	Mandrel Break Load		Tensile (Min.)		Shear (Min.)	
								N	LBS	N	LBS	N	LBS
<b>D-0.15/+0.1 x L+0.5/-0.3</b>		(Min.) ~ (Max.)	(H) ±0.2	(E) ±0.2	(Min.) ~ (Max.)	(P) (Min.)	(W) ±0.10						
4.0 x 13.6	5-5	4.1 ~ 4.2	8.0	1.4	1.0 ~ 3.0	27	2.3	1000 1200	225 270	750	170	550	125
4.0 x 19.0	5-6	4.1 ~ 4.2	8.0	1.4	3.0 ~ 7.0	27	2.3	1000 1200	225 270	750	170	550	125
4.0 x 24.0	5-7	4.1 ~ 4.2	8.0	1.4	4.0 ~ 12.0	27	2.3	1000 1200	225 270	750	170	550	125
4.8 x 15.3	6-5	4.9 ~ 5.0	9.8	1.8	1.0 ~ 4.0	28	2.9	1900 2100	427 472	1070	240	780	175
4.8 x 20.5	6-6	4.9 ~ 5.0	9.8	1.8	1.0 ~ 9.0	28	2.9	1900 2100	427 472	1070	240	780	175
4.8 x 24.5	6-7	4.9 ~ 5.0	9.8	1.8	4.0 ~ 12.0	28	2.9	1900 2100	427 472	1070	240	780	175
5.2 x 17.9	8-1	5.3 ~ 5.4	10.0	2.0	1.2 ~ 4.8	28	2.9	2000 2300	450 517	1400	315	2300	517
5.2 x 20.5	8-2	5.3 ~ 5.4	10.0	2.0	1.5 ~ 6.4	28	2.9	2000 2300	450 517	1400	315	2300	517

## Large Flange Head

Rivet size (D x L) (mm)	Rivet Code	Hole Dia (mm)	Head Dia (mm)	Head Thickness	Grip Range (mm)	Mandrel Protrusion	Mandrel Dia. (mm)	Mandrel Break Load		Tensile (Min.)		Shear (Min.)	
								N	LBS	N	LBS	N	LBS
<b>D-0.15/+0.1 x L+0.5/-0.3</b>		(Min.) ~ (Max.)	(H) ±0.2	(E) ±0.2	(Min.) ~ (Max.)	(P) (Min.)	(W) ±0.10						
4.8 x 15.3	6-5	4.9 ~ 5.0	16.0	2.0	1.0 ~ 4.0	28	2.9	1900 2100	427 472	1070	240	780	175
4.8 x 20.5	6-6	4.9 ~ 5.0	16.0	2.0	1.0 ~ 9.0	28	2.9	1900 2100	427 472	1070	240	780	175
4.8 x 24.5	6-7	4.9 ~ 5.0	16.0	2.0	4.0 ~ 12.0	28	2.9	1900 2100	427 472	1070	240	780	175

**Bulb-Tite Blind Rivet**

Material	
1	Rivet Body - Aluminium Mandrel - Aluminium

Key Features	
1	Large grip range
2	Vibration-proof
3	Use on straight curved application parts
4	Waterproof with neoprene sealing washer
5	Large distribution of the grip force over a large surface

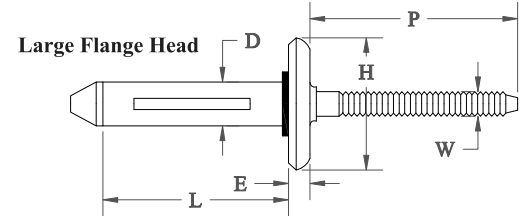
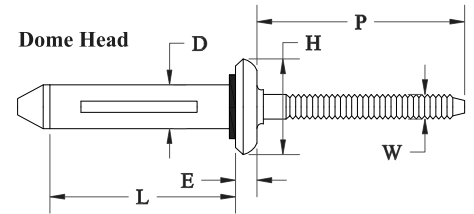
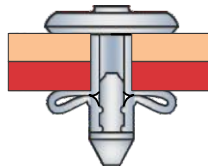
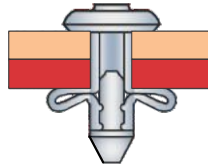

**Bulb-Tite Rivet Aluminium/Aluminium**

Dome Head											
Rivet size (D x L) (mm)	Rivet Code	Hole Dia (mm)	Head Dia (H) (mm)	Head Thickness (E) ± 0.2	Grip Range (mm)	Mandrel Protrusion (P) (Min.)	Mandrel Dia. (W) ± 0.10	Tensile (Min.)		Shear (Min.)	
D-0.15/+0.1 x L+0.5/-0.3		(Min.) ~ (Max.)	(Min.) ~ (Max.)		(Min.) ~ (Max.)			N	LBS	N	LBS
4.0 x 20.3	5-1	4.1 ~ 4.2	8.5 ~ 8.9	2.5	1.5 ~ 6.4	27.0	2.3	1050	236	2000	450
4.0 x 25.1	5-2	4.1 ~ 4.2	8.5 ~ 8.9	2.5	6.4 ~ 12.7	27.0	2.3	1050	236	2000	450
5.2 x 17.5	6-1	5.3 ~ 5.5	10.9 ~ 11.6	3.2	1.3 ~ 4.8	28.0	2.9	1950	438	2700	607
5.2 x 19.1	6-2	5.3 ~ 5.5	10.9 ~ 11.6	3.2	1.6 ~ 6.4	28.0	2.9	1950	438	2700	607
5.2 x 22.2	6-3	5.3 ~ 5.5	10.9 ~ 11.6	3.2	4.7 ~ 9.5	28.0	2.9	1950	438	2700	607
5.2 x 25.4	6-4	5.3 ~ 5.5	10.9 ~ 11.6	3.2	7.9 ~ 12.7	28.0	2.9	1950	438	2700	607
5.2 x 28.6	6-5	5.3 ~ 5.5	10.9 ~ 11.6	3.2	11.1 ~ 15.9	28.0	2.9	1950	438	2700	607
5.2 x 31.8	6-6	5.3 ~ 5.5	10.9 ~ 11.6	3.2	14.3 ~ 19.1	28.0	2.9	1950	438	2700	607
5.2 x 34.9	6-7	5.3 ~ 5.5	10.9 ~ 11.6	3.2	17.4 ~ 22.2	28.0	2.9	1950	438	2700	607
5.2 x 38.1	6-8	5.3 ~ 5.5	10.9 ~ 11.6	3.2	20.6 ~ 25.4	28.0	2.9	1950	438	2700	607
5.2 x 41.3	6-9	5.3 ~ 5.5	10.9 ~ 11.6	3.2	23.8 ~ 28.6	28.0	2.9	1950	438	2700	607
6.3 x 20.2	7-1	6.4 ~ 6.6	14.0 ~ 14.4	3.8	1.6 ~ 6.4	28.0	3.8	2500	562	4200	944
6.3 x 23.4	7-2	6.4 ~ 6.6	14.0 ~ 14.4	3.8	3.2 ~ 9.5	28.0	3.8	2500	562	4200	944
6.3 x 26.5	7-3	6.4 ~ 6.6	14.0 ~ 14.4	3.8	6.4 ~ 12.7	28.0	3.8	2500	562	4200	944
6.3 x 29.7	7-4	6.4 ~ 6.6	14.0 ~ 14.4	3.8	9.5 ~ 15.9	28.0	3.8	2500	562	4200	944
7.7 x 27.7	8-1	7.8 ~ 8.2	15.5 ~ 15.7	4.8	1.0 ~ 9.5	28.0	4.4	4850	1090	6650	1495
Large Flange Head											
Rivet size (D x L) (mm)	Rivet Code	Hole Dia (mm)	Head Dia (H) (mm)	Head Thickness (E) ± 0.2	Grip Range (mm)	Mandrel Protrusion (P) (Min.)	Mandrel Dia. (W) ± 0.10	Tensile (Min.)		Shear (Min.)	
D-0.15/+0.1 x L+0.5/-0.3		(Min.) ~ (Max.)	(Min.) ~ (Max.)		(Min.) ~ (Max.)			N	LBS	N	LBS
7.7 x 27.7	8-1	7.8 ~ 8.2	18.3 ~ 19.4	5.3	1.1 ~ 9.5	28.0	4.4	4850	1090	6650	1495
7.7 x 34.0	8-2	7.8 ~ 8.2	18.3 ~ 19.4	5.3	6.4 ~ 15.9	28.0	4.4	4850	1090	6650	1495

Bulb-Tite Rivets Of All Head Types optionally Available With Washer, too.

## Bulb-Tite Blind Rivet

Material	
1	Rivet Body - Steel Mandrel - Steel
2	Rivet Body - Monel Mandrel - Stainless Steel



Key Features	
1	Large grip range
2	Vibration-proof
3	Use on straight curved application parts
4	Waterproof with neoprene sealing washer
5	Large distribution of the grip force over a large surface

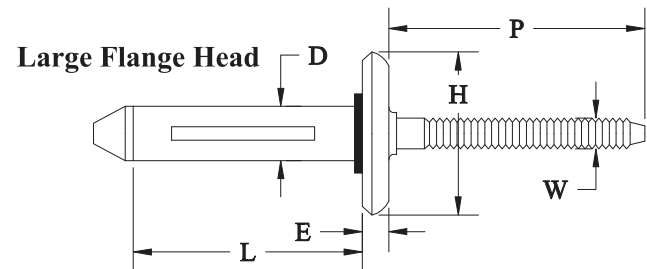
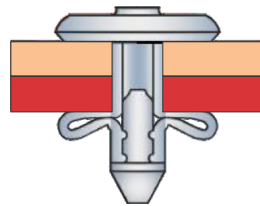
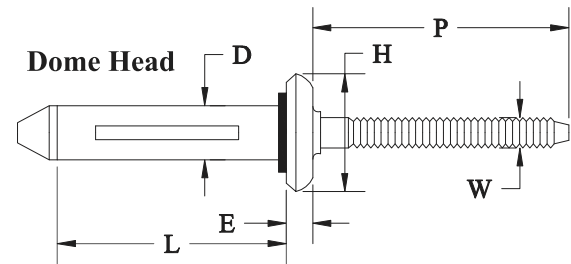
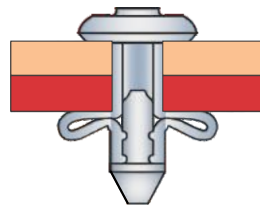

## Bulb-Tite Rivet Steel/Steel

## Dome Head

Rivet size (D x L) (mm)	Rivet Code	Hole Dia (mm)	Head Dia (H) (mm)	Head Thickness	Grip Range (mm)	Mandrel Protrusion	Mandrel Dia. (mm)	Tensile (Min.)		Shear (Min.)	
<b>D-0.15/+0.1 x L+0.5/-0.3</b>		(Min.) ~ (Max.)	(Min.) ~ (Max.)	(E) ± 0.2	(Min.) ~ (Max.)	(P) (Min.)	(W) ± 0.10	N	<b>LBS</b>	N	<b>LBS</b>
5.2 x 19.1	6-2	5.3 ~ 5.5	10.9 ~ 11.6	3.2	1.6 ~ 6.4	28.0	2.9	2890	649	3890	874
5.2 x 22.2	6-3	5.3 ~ 5.5	10.9 ~ 11.6	3.2	4.7 ~ 9.5	28.0	2.9	2890	649	3890	874
5.2 x 25.4	6-4	5.3 ~ 5.5	10.9 ~ 11.6	3.2	7.9 ~ 12.7	28.0	2.9	2890	649	3890	874
5.2 x 28.6	6-5	5.3 ~ 5.5	10.9 ~ 11.6	3.2	11.1 ~ 15.9	28.0	2.9	2890	649	3890	874
5.2 x 31.8	6-6	5.3 ~ 5.5	10.9 ~ 11.6	3.2	14.3 ~ 19.1	28.0	2.9	2890	649	3890	874
6.3 x 20.2	7-1	6.4 ~ 6.6	14.0 ~ 14.4	3.8	1.6 ~ 6.4	28.0	3.8	4550	1022	8200	1843
6.3 x 23.4	7-2	6.4 ~ 6.6	14.0 ~ 14.4	3.8	3.2 ~ 9.5	28.0	3.8	4550	1022	8200	1843

## Bulb-Tite Rivet Monel/Stainless Steel

## Dome Head

Rivet size (D x L) (mm)	Rivet Code	Hole Dia (mm)	Head Dia (H) (mm)	Head Thickness	Grip Range (mm)	Mandrel Protrusion	Mandrel Dia. (mm)	Tensile (Min.)		Shear (Min.)	
<b>D-0.15/+0.1 x L+0.5/-0.3</b>		(Min.) ~ (Max.)	(Min.) ~ (Max.)	(E) ± 0.2	(Min.) ~ (Max.)	(P) (Min.)	(W) ± 0.10	N	<b>LBS</b>	N	<b>LBS</b>
6.3 x 20.2	7-1	6.4 ~ 6.6	14.0 ~ 14.4	3.8	1.0 ~ 6.4	28.0	3.8	4400	989	7800	1753

Bulb-Tite Rivets Of All Head Types optionally Available With Washer, too.

**H-LOCK Rivet**

Material	
1	Rivet Body - Steel Mandrel - Steel

Key Features	
1	Very high shear and tensile strength
2	Large blind side bearing area
3	Interference lock via splined Stem



Dome Head

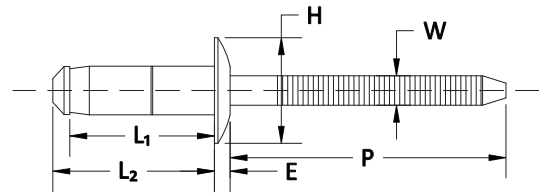
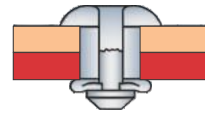

H-LOCK Steel																		
Rivet Size (mm)				Rivet Code	Hole Dia	Domed Head Dia		Head Height	Mandrel Dia	Mandrel Protrusion	Domed Head Grip Range	H Lok Rivet Body - Steel Mandrel - Steel						
D	L <sub>1</sub>	D	L <sub>2</sub>		H		E	W	P		Tensile Min.		Shear Min.		Mandrel Break Load			
-0.2	Max.	-0.2	Max.		Min.~ Max.	Min.	Max.	Max.	Nom	Min.	Min.~Max.	N	LBS	N	LBS	N	LBS	
6.4	9.4	6.4	13.7	7-1	6.5~6.7	12.8	13.4	2.7	4.1	27.0	1.50 ~ 3.50	8800	1978	10500	2360	Min.	13789	3100
	10.7		15.0	7-2	6.5~6.7	12.8	13.4	2.7	4.1	27.0	2.80 ~ 4.80	8800	1978	12000	2698			
	11.3		15.6	7-3	6.5~6.7	12.8	13.4	2.7	4.1	27.0	3.40 ~ 5.40	8800	1978	12000	2698			
	12.7		17.0	7-4	6.5~6.7	12.8	13.4	2.7	4.1	27.0	4.80 ~ 6.80	8800	1978	12500	2810			
	14.7		19.0	7-5	6.5~6.7	12.8	13.4	2.7	4.1	27.0	6.80 ~ 8.80	8800	1978	14000	3147	Max.	15568	3500
	15.4		19.7	7-6	6.5~6.7	12.8	13.4	2.7	4.1	27.0	7.50 ~ 9.50	8800	1978	14000	3147			
	15.7		20.0	7-7	6.5~6.7	12.8	13.4	2.7	4.1	27.0	7.80 ~ 9.80	8800	1978	14000	3147			
	16.7		21.0	7-8	6.5~6.7	12.8	13.4	2.7	4.1	27.0	8.80 ~ 10.80	8800	1978	16000	3597			
18.7	23.0	7-9	6.5~6.7	12.8	13.4	2.7	4.1	27.0	10.80 ~ 12.80	8800	1978	16000	3597					
20.4	24.8	7-10	6.5~6.7	12.8	13.4	2.7	4.1	27.0	12.60 ~ 14.60	8800	1978	16000	3597					
7.8	13.5	7.8	17.5	8-1	8.1~8.3	16.0	18.0	4.2	5.1	28.0	4.0~7.0	9100	2046	13500	3035			
	16.5		20.5	8-2	8.1~8.3	16.0	18.0	4.2	5.1	28.0	7.0~10.0	9100	2046	16000	3597			
	19.5		23.5	8-3	8.1~8.3	16.0	18.0	4.2	5.1	28.0	10.0~13.0	9100	2046	16000	3597			
	22.5		26.5	8-4	8.1~8.3	16.0	18.0	4.2	5.1	28.0	13.0~16.0	9100	2046	16000	3597			

Material	
1	Rivet Body - Aluminium Mandrel - Aluminium

Key Features	
1	Very high shear and tensile strength
2	Large blind side bearing area
3	Interference lock via splined stem



Dome Head

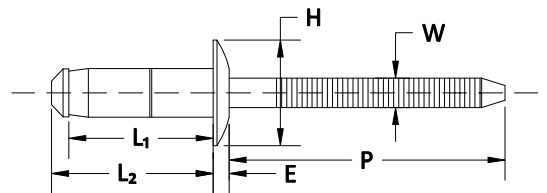
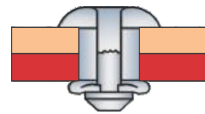

H-LOCK Aluminium																		
Rivet Size (mm)				Rivet Code	Hole Dia	Domed Head Dia		Head Height	Mandrel Dia	Mandrel Protrusion	Domed Head Grip Range	H Lok Rivet Body - Aluminium Mandrel - Aluminium						
D	L <sub>1</sub>	D	L <sub>2</sub>		H		E	W	P		Tensile Min.		Shear Min.		Mandrel Break Load			
-0.2	Max.	-0.2	Max.		Min.~ Max.	Min.	Max.	Max.	Nom	Min.	Min.~Max.	N	LBS	N	LBS	N	LBS	
6.4	9.4	6.4	13.7	7-1	6.5~6.7	12.8	13.4	2.7	4.1	27.0	1.50 ~ 3.50	2670	600	5000	1124	Min.	5560	1250
	10.7		15.0	7-2	6.5~6.7	12.8	13.4	2.7	4.1	27.0	2.80 ~ 4.80	2670	600	6000	1348			
	11.3		15.6	7-3	6.5~6.7	12.8	13.4	2.7	4.1	27.0	3.40 ~ 5.40	2670	600	6200	1393			
	12.7		17.0	7-4	6.5~6.7	12.8	13.4	2.7	4.1	27.0	4.80 ~ 6.80	2670	600	6500	1461	Max.	7339	1650
	14.7		19.0	7-5	6.5~6.7	12.8	13.4	2.7	4.1	27.0	6.80 ~ 8.80	2670	600	7000	1573			
	16.7		21.0	7-8	6.5~6.7	12.8	13.4	2.7	4.1	27.0	8.80 ~ 10.80	2670	600	7000	1573			
18.7	23.0	7-9	6.5~6.7	12.8	13.4	2.7	4.1	27.0	10.80 ~ 12.80	2670	600	7000	1573					

**M-Bolt Blind Rivet Aluminium**



**Domed Head**

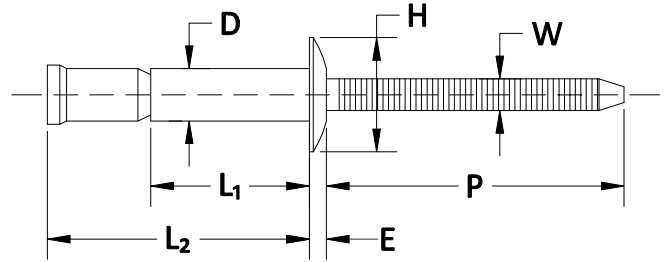
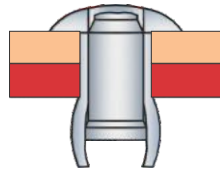

Material	
1	Rivet Body - Aluminium Mandrel - Aluminium

Key Features	
1	Multi-grip capability
2	Fully sealed fastener
3	Visible lock
4	Excellent hole fill
5	Mechanically locked stem
6	Good sheet take-up performance



**CSK Head**

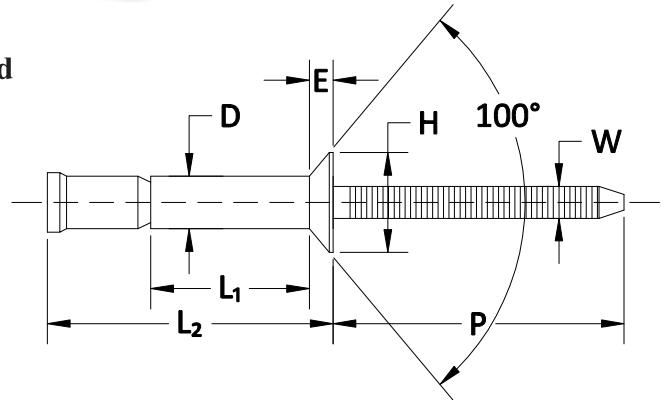
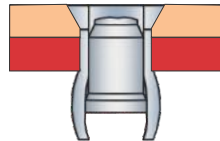

<b>M-Bolt</b>																		
<b>Domed Head</b>																		
Rivet Size (mm)				Rivet Code	Hole Dia	Domed Head Dia		Head Height	Mandrel Dia	Mandrel Protrusion	Domed Head Grip Range	M-Bolt Rivet Body - Aluminium Mandrel - Aluminium						
D	L <sub>1</sub>	D	L <sub>2</sub>		Min.~Max.	Min.	Max.	E	W	P	Min.~Max.	Tensile Min.		Shear Min.		Mandrel Break Load		
-0.2	Max.	-0.2	Max.					Max.	Nom	Min.	Min.~Max.	N	LBS	N	LBS	N	LBS	
4.8	10.7	4.8	18.4	6-1	4.9 ~ 5.1	9.0	10.1	2.1	3.1	27.0	1.63 ~ 6.86	2200	495	3000	674	Min.	3336	750
	13.9		24.1	6-2							1.63 ~ 11.10					Max.	4670	1050
6.4	15.9	6.4	24.6	7-1	6.6 ~ 7.0	12.0	13.4	2.9	4.1	27.0	2.03 ~ 9.53	4200	944	6000	1348	Min.	5560	1250
	23.0		34.7	7-2							2.03 ~ 15.87					Max.	7339	1650
10.0		10.0	36.2	8-1	9.95 ~ 10.4	19.0	20.3	4.1	6.1	27.0	3.04 ~ 15.88	9300	2090	12600	2832	Min.	N/A	N/A
																Max.	N/A	N/A
<b>CSK Head</b>																		
Rivet Size (mm)				Rivet Code	Hole Dia	CSK Head Dia 100°		Head Height	Mandrel Dia	Mandrel Protrusion	CSK HEAD Grip Range	M-Bolt Rivet Body - Aluminium Mandrel - Aluminium						
D	L <sub>1</sub>	D	L <sub>2</sub>		Min.~Max.	Min.	Max.	E	W	P	Min.~Max.	Tensile Min.		Shear Min.		Mandrel Break Load		
-0.2	Max.	-0.2	Max.					Max.	Nom	Min.	Min.~Max.	N	LBS	N	LBS	N	LBS	
4.8	12.1	4.8	20.0	6-1	4.9 ~ 5.1	8.3	9.0	2.2	3.1	27.0	3.17 ~ 8.41	2100	472	2800	629	Min.	3336	750
	15.2		26.3	6-2							3.17 ~ 12.22					Max.	4670	1050
6.4	16.6	6.4	27.2	7-1	6.6 ~ 7.0	10.1	10.8	2.4	4.1	27.0	3.17 ~ 12.07	4200	944	6000	1348	Min.	5560	1250
																Max.	7339	1650

**M-Bolt Blind Rivet Steel**

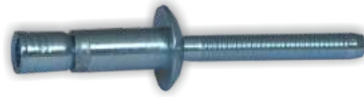

**Domed Head**

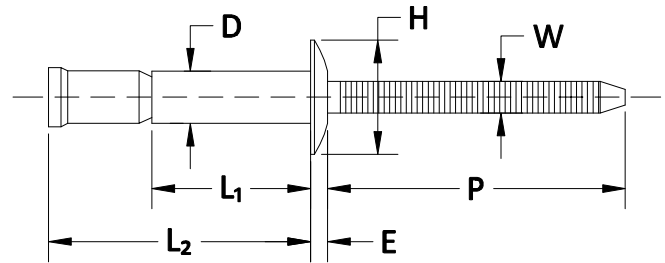
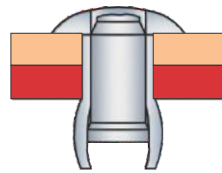

Material	
1	Rivet Body - Steel Mandrel - Steel

Key Features	
1	Multi-grip capability
2	Fully sealed fastener
3	Visible lock
4	Excellent hole fill
5	Mechanically locked stem
6	Good sheet take-up performance



**CSK Head**

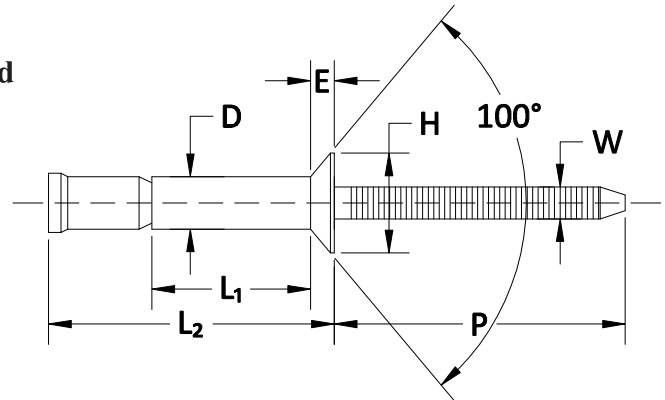
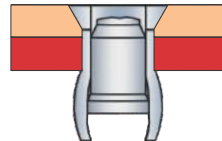

<b>M-Bolt</b>																		
<b>Domed Head</b>																		
Rivet Size (mm)				Rivet Code	Hole Dia	Domed Head Dia		Head Height	Mandrel Dia	Mandrel Protrusion	Domed Head Grip Range	M-Bolt Rivet Body - Steel Mandrel - Steel						
D	L <sub>1</sub>	D	L <sub>2</sub>			H		E	W	P		Tensile Min.	Shear Min.	Mandrel Break Load				
-0.2	Max.	-0.2	Max.		Min.~ Max.	Min.	Max.	Max.	Nom	Min.	Min.~Max.	N	LBS	N	LBS		N	LBS
4.8	10.5	4.8	18.2	6-1	4.9 ~ 5.1	9.0	10.1	2.1	3.1	27.0	1.63 ~ 6.86	5100	1146	6400	1438	Min.	5560	1250
	14.3		6-2	24.5							6-2					27.0	1.63 ~ 11.10	Max.
6.4	14.0	6.4	23.7	7-1	6.6 ~ 7.0	12.0	13.4	2.9	4.1	27.0	2.03 ~ 9.53	10400	2338	11700	2630	Min.	9118	2050
	20.3		7-2	33.0							7-2					27.0	2.03 ~ 15.87	Max.
10.0		10.0	36.2	8-1	9.95 ~ 10.4	19.0	20.3	4.1	6.1	27.0	3.04 ~ 15.88	17500	3934	26300	5912	Min.	N/A	N/A
																Max.	N/A	N/A
<b>CSK Head</b>																		
Rivet Size (mm)				Rivet Code	Hole Dia	CSK Head Dia 100°		Head Height	Mandrel Dia	Mandrel Protrusion	CSK Head Grip Range	M-Bolt Rivet Body - Steel Mandrel - Steel						
D	L <sub>1</sub>	D	L <sub>2</sub>			H		E	W	P		Tensile Min.	Shear Min.	Mandrel Break Load				
-0.2	Max.	-0.2	Max.		Min.~ Max.	Min.	Max.	Max.	Nom	Min.	Min.~Max.	N	LBS	N	LBS		N	LBS
4.8	12.1	4.8	20.0	6-1	4.9 ~ 5.1	8.3	9.0	2.2	3.1	27.0	3.17 ~ 8.41	5100	1146	6400	1438	Min.	5560	1250
	15.2		6-2	26.3							6-2					27.0	3.17 ~ 12.22	Max.
6.4	16.6	6.4	26.4	7-1	6.6 ~ 7.0	10.1	10.8	2.4	4.1	27.0	3.17 ~ 12.07	10400	2338	11700	2630	Min.	9118	2050
																Max.	10898	2450



**M-Bolt Blind Rivet Stainless Steel**



**Domed Head**

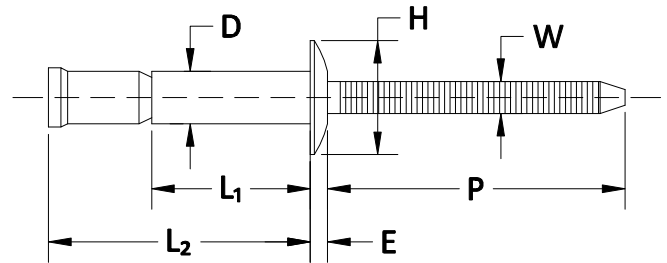
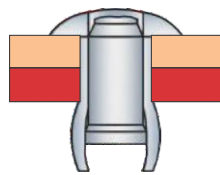

Material	
1	Rivet Body - Stainless Steel Mandrel - Stainless Steel

Key Features	
1	Multi-grip capability
2	Fully sealed fastener
3	Visible lock
4	Excellent hole fill
5	Mechanically locked stem
6	Good sheet take-up performance



**CSK Head**

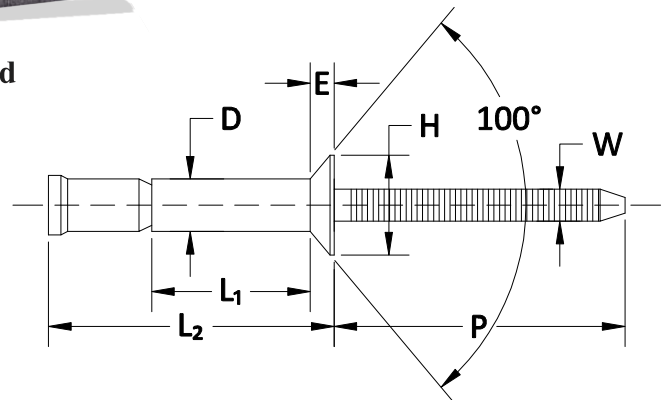
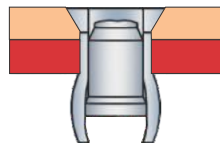

<b>M-Bolt</b>																		
<b>Domed Head</b>																		
Rivet Size (mm)				Rivet Code	Hole Dia	Domed Head Dia		Head Height	Mandrel Dia	Mandrel Protrusion	Domed Head Grip Range	M-Bolt Rivet Body - Stainless Steel Mandrel - Stainless Steel						
D	L <sub>1</sub>	D	L <sub>2</sub>		H		E	W	P	Tensile Min.		Shear Min.		Mandrel Break Load				
-0.2	Max.	-0.2	Max.		Min.~ Max.	Min.	Max.	Max.	Nom	Min.	Min.~ Max.	N	LBS	N	LBS	N	LBS	
4.8	10.5	4.8	18.2	6-1	4.9 ~ 5.1	9.0	10.1	2.1	3.1	27.0	1.63 ~ 6.86	5100	1146	6400	1438	Min.	4893	1100
	14.3		6-2	24.5							27.0					1.63 ~ 11.10	Max.	6227
6.4	14.0	6.4	23.7	7-1	6.6 ~ 7.0	12.0	13.4	2.9	4.1	27.0	2.03 ~ 9.53	10400	2338	11700	2630	Min.	9118	2050
	20.3		7-2	33.0							27.0					2.03 ~ 15.87	Max.	10898
10.0		10.0	36.2	8-1	9.95 ~ 10.4	19.0	20.3	4.1	6.1	27.0	3.04 ~ 15.88	19400	4361	26100	5867	Min.	N/A	N/A
																Max.	N/A	N/A
<b>CSK Head</b>																		
Rivet Size (mm)				Rivet Code	Hole Dia	CSK Head Dia 100°		Head Height	Mandrel Dia	Mandrel Protrusion	CSK Head Grip Range	M-Bolt Rivet Body - Stainless Steel Mandrel - Stainless Steel						
D	L <sub>1</sub>	D	L <sub>2</sub>		H		E	W	P	Tensile Min.		Shear Min.		Mandrel Break Load				
-0.2	Max.	-0.2	Max.		Min.~ Max.	Min.	Max.	Max.	Nom	Min.	Min.~ Max.	N	LBS	N	LBS	N	LBS	
4.8	12.1	4.8	20.0	6-1	4.9 ~ 5.1	8.3	9.0	2.2	3.1	27.0	3.17 ~ 8.41	5100	1146	6400	1438	Min.	4893	1100
	15.2		6-2	26.3							27.0					3.17 ~ 12.22	Max.	6227
6.4	16.6	6.4	26.4	7-1	6.6 ~ 7.0	10.1	10.8	2.4	4.1	27.0	3.17 ~ 12.07	10400	2338	11700	2630	Min.	9118	2050
																Max.	10898	2450

**I-Lock Blind Rivet**



Material	
1	Rivet Body - Steel Mandrel - Steel

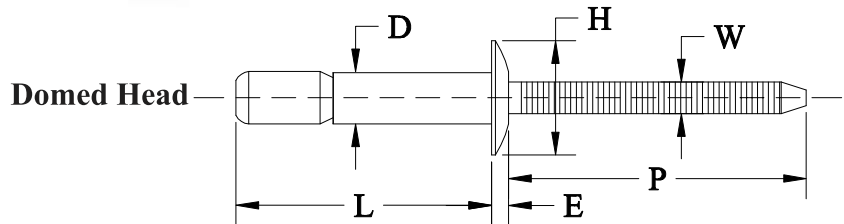
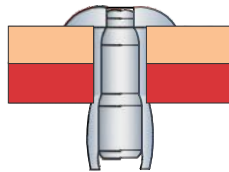

Key Features	
1	Multi-grip capability
2	Fully sealed fastener
3	Excellent hole fill
4	Mechanically locked stem
5	Good sheet take-up performance

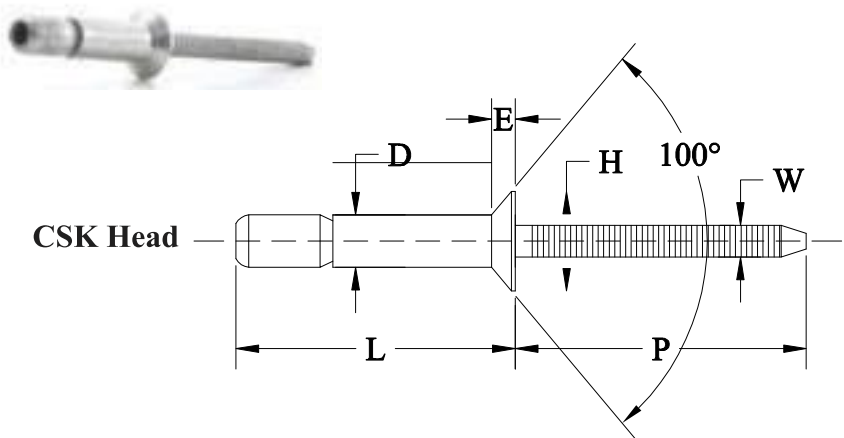
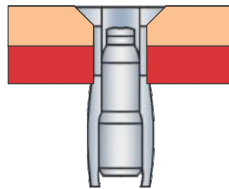

I-Lock Steel																
Domed Head																
Nom Rivet Size (mm)		Rivet Code	Hole Dia	Domed Head Dia		Head Height	Mandrel Dia	Mandrel Protrusion	Domed Head Grip Range	I-Lock Rivet Body - Steel Mandrel - Steel						
D	L		Min.~ Max.	Min.	Max.	Max.	Nom	Min.	Min.~ Max.	Tensile Min.		Shear Min.		Mandrel Break Load		
-0.2	Max.									N	LBS	N	LBS	N	LBS	
4.8	18.2	6-1	4.93 ~ 5.18	9.0	10.2	2.3	3.1	27.0	1.57 ~ 6.35	4440	998	5780	1299	Min.	5560	1250
	25.5	6-2							5.44 ~ 11.10							
	25.5	6-2.1							1.57 ~ 11.10							
	27.7	6-3							9.53 ~ 15.88							
6.4	30.0	7-1	6.63 ~ 7.01	12.0	13.5	3.0	4.1	27.0	2.03 ~ 9.53	8220	1847	10670	2398	Min.	12232	2750
	33.7	7-2							8.89 ~ 15.88							
	36.2	7-3							2.03 ~ 15.88							
10.0	39.4	8-1	9.96 ~ 10.39	19.0	19.6	4.4	6.1	27.0	3.05 ~ 15.88	16010	3599	26240	5898	Min.	N/A	N/A
														Max.	N/A	N/A
CSK Head																
Nom Rivet Size (mm)		Rivet Code	Hole Dia	CSK Head Dia		Head Height	Mandrel Dia	Mandrel Protrusion	CSK Head Grip Range	I-Lock Rivet Body - Steel Mandrel - Steel						
D	L		Min.~ Max.	Min.	Max.	Max.	Nom	Min.	Min.~ Max.	Tensile Min.		Shear Min.		Mandrel Break Load		
-0.2	Max.									N	LBS	N	LBS	N	LBS	
4.8	20.2	6-1	4.93 ~ 5.18	8.5	9.2	1.8	3.1	27.0	3.18 ~ 8.41	4440	998	5780	1299	Min.	5560	1250
														Max.	6894	1550
6.4	28.4	7-1	6.63 ~ 7.01	10.7	11.4	2.0	4.1	27.0	4.32 ~ 12.07	8220	1847	10670	2398	Min.	9118	2050
														Max.	10898	2450

I-Lock Blind Rivet

Material		
1	Rivet Body - Stainless Steel	Mandrel - Stainless Steel

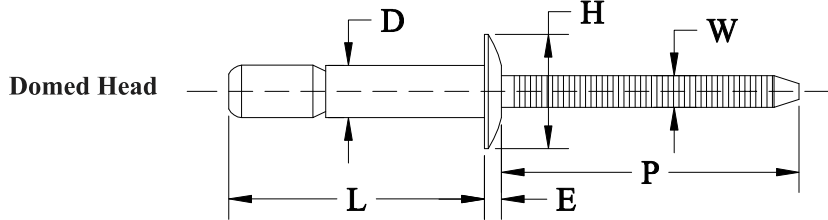
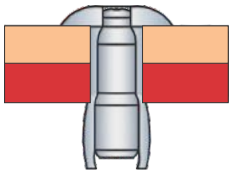

Key Features	
1	Multi-grip capability
2	Fully sealed fastener
3	Excellent hole fill
4	Mechanically locked stem
5	Good sheet take-up performance

I-Lock Stainless Steel																
Domed Head																
Nom Rivet Size (mm)		Rivet Code	Hole Dia	Domed Head Dia		Head Height	Mandrel Dia	Mandrel Protrusion	Domed Head Grip Range	I-Lock Rivet Body - Stainless Steel Mandrel - Stainless Steel						
D	L		Min.~ Max.	Min.	Max.	Max.	Nom	Min.	Min.~ Max.	Tensile Min.		Shear Min.		Mandrel Break Load		
-0.2	Max.									N	LBS	N	LBS	N	LBS	
4.8	21.4	6-1	4.93 ~ 5.18	9.0	10.2	2.3	3.1	27.0	1.57 ~ 6.35	4440	998	5780	1299	Min.	4893	1100
	25.5	6-2							1.57 ~ 11.10					Max.	6227	1400
6.4	28.4	7-1	6.63 ~ 7.01	12.0	13.5	3.0	4.1	27.0	2.03 ~ 9.53	8220	1847	10670	2398	Min.	9118	2050
	36.4	7-3							2.03 ~ 15.88					Max.	10898	2450

Material		
1	Rivet Body - Aluminium	Mandrel - Aluminium

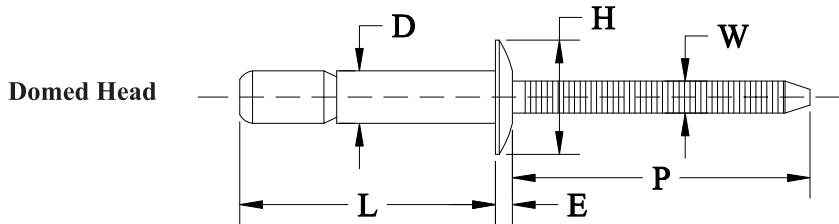
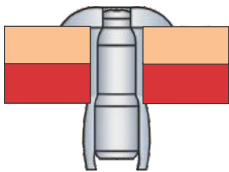

Key Features	
1	Multi-grip capability
2	Fully sealed fastener
3	Excellent hole fill
4	Mechanically locked stem
5	Good sheet take-up performance

I-Lock Aluminium																
Domed Head																
Nom Rivet Size (mm)		Rivet Code	Hole Dia	Domed Head Dia		Head Height	Mandrel Dia	Mandrel Protrusion	Domed Head Grip Range	I-Lock Rivet Body - Aluminium Mandrel - Aluminium						
D	L		Min.~ Max.	Min.	Max.	Max.	Nom	Min.	Min.~ Max.	Tensile Min.		Shear Min.		Mandrel Break Load		
-0.2	Max.									N	LBS	N	LBS	N	LBS	
4.8	21.4	6-1	4.93 ~ 5.18	9.0	10.2	2.3	3.1	27.0	1.57 ~ 6.35	2000	449	2400	539	Min.	3336	750
	22.3	6-2							5.44 ~ 11.10					Max.	4670	1050
	24.8	6-3							1.57 ~ 11.10							
	27.7	6-4							9.53 ~ 15.88							
6.4	30.0	7-1	6.63 ~ 7.01	12.0	13.5	3.0	4.1	27.0	2.03 ~ 9.53	3600	809	5600	1258	Min.	4893	1100
	33.1	7-2							8.89 ~ 15.88					Max.	6227	1400
	35.6	7-3							2.03 ~ 15.88							

**St-Bulb Blind Rivet**

Material	
1	Rivet Body - Steel Mandrel - Steel

Key Features	
1	High shear and tensile strength
2	Retained stem
3	Large blind side bearing area

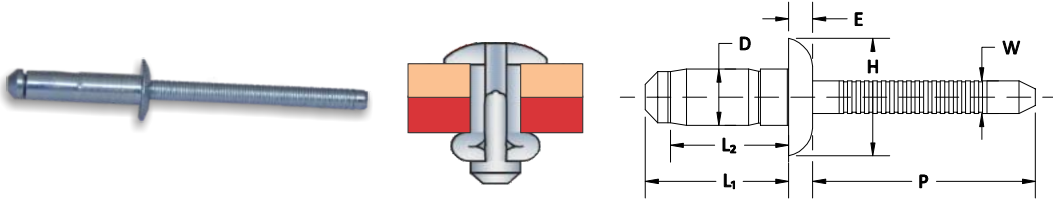

St-Bulb Blind Rivet																					
Nom Rivet Size (mm)		Nom Rivet Size (mm)		Rivet Code	Hole Dia	Domed Head Dia		Head Height	Mandrel Dia	Mandrel Protusion	Domed Head Grip Range	Material		St-Bulb Rivet Body - Steel Mandrel - Steel							
D	L <sub>1</sub>	D	L <sub>2</sub>			H						E	W	P	Tensile Min.	Shear Min.	Mandrel Break Load				
					Min.~Max.	Min.	Max.	Max.	Max.	Min.	Min.~Max.	N	LBS	N	LBS	N	LBS				
-0.2	Max.	-0.2	Max.																		
3.2	9.1	3.2	6.6	4-1	3.3~3.4	6.05	6.65	1.20	2.10	25.4	1.0~3.0	1040	234	960	215	Min.	1000	225			
3.2	11.7	3.2	9.2	4-2	3.3~3.4	6.05	6.65	1.20	2.10	25.4	3.0~5.0			1360	305	Max.	2200	495			
3.2	14.0	3.2	11.5	4-3	3.3~3.4	6.05	6.65	1.20	2.10	25.4	5.0~7.0			2000	450						
4.0	10.4	4.0	7.3	5-2	4.1~4.3	7.52	8.33	1.50	2.70	26.9	1.0~3.0	2210	497	1920	432	Min.	2000	450			
4.0	12.9	4.0	9.9	5-3	4.1~4.3	7.52	8.33	1.50	2.70	26.9	3.0~5.0			2800	629	Max.	3200	719			
4.0	15.7	4.0	12.7	5-4	4.1~4.3	7.52	8.33	1.50	2.70	26.9	5.0~7.0			3280	737						
4.0	18.1	4.0	15.1	5-5	4.1~4.3	7.52	8.33	1.50	2.70	26.9	7.0~9.0	2000	450	2640	593	Max.	4800	1079			
4.8	12.1	4.8	8.6	6-2	4.9~5.1	9.05	10.00	1.60	3.10	26.9	1.5~3.5	3040	683	2880	647				Min.	3000	674
4.8	14.7	4.8	11.2	6-4	4.9~5.1	9.05	10.00	1.60	3.10	26.9	3.5~6.0			3360	755				Max.	4800	1079
4.8	17.6	4.8	14.1	6-5	4.9~5.1	9.05	10.00	1.60	3.10	26.9	6.0~8.5			4480	1007						
6.0	14.0	6.0	10.0	7-1	6.1~6.3	10.50	12.00	2.50	4.00	30.0	1.5~4.0	4320	971	3360	822	Min.	5200	1169			
6.0	17.0	6.0	13.0	7-2	6.1~6.3	10.50	12.00	2.50	4.00	30.0	3.0~6.0			4320	971	Max.	7200	1618			
6.0	20.0	6.0	16.0	7-3	6.1~6.3	10.50	12.00	2.50	4.00	30.0	6.0~9.0			6800	1528						
6.0	23.0	6.0	19.0	7-4	6.1~6.3	10.50	12.00	2.50	4.00	30.0	9.0~12.0			6800	1528						
6.4	17.3	6.4	12.5	8-1	6.6~7.0	11.50	13.00	2.70	4.20	30.0	1.5~5.5	5440	1222	8880	1996	Min.	5800	1303			
6.4	21.3	6.4	16.5	8-2	6.6~7.0	11.50	13.00	2.70	4.20	30.0	5.0~9.0			8880	1996	Max.	7800	1753			

Material	
1	Rivet Body - Stainless Steel Mandrel - Stainless Steel

**St-Nox Blind Rivet**

Key Features	
1	High shear and tensile strength
2	High corrosion resistance
3	Retained stem
4	Large blind side bearing area

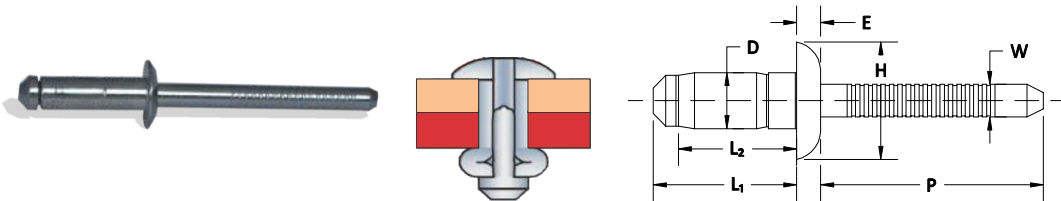

St-Nox Blind Rivet																		
Nom Rivet Size (mm)		Nom Rivet Size (mm)		Rivet Code	Hole Dia	Domed Head Dia		Head Height	Mandrel Dia	Mandrel Protusion	Domed Head Grip Range	Material		St-Nox Rivet Body - Stainless Steel Mandrel - Stainless Steel				
D	L <sub>1</sub>	D	L <sub>2</sub>			H						E	W	P	Tensile Min.	Shear Min.	Mandrel Break Load	
					Min.~Max.	Min.	Max.	Max.	Nom	Min.	Min.~Max.	N	LBS	N	LBS	N	LBS	
3.2	9.1	3.2	6.7	4-1	3.3~3.4	6.05	6.65	1.20	2.20	25.4	1.0~3.0	1600	360	1280	288	Min.	1600	360
3.2	11.7	3.2	9.3	4-3	3.3~3.4	6.05	6.65	1.20	2.20	25.4	3.0~5.0			1360	306	Max.	3200	719
3.2	14.0	3.2	11.6	4-4	3.3~3.4	6.05	6.65	1.20	2.20	25.4	5.0~7.0			2560	575			
4.0	10.4	4.0	7.3	5-1	4.1~4.3	7.52	8.33	1.50	2.70	26.9	1.0~3.0	3200	719	2240	503	Min.	3200	719
4.0	12.9	4.0	9.9	5-3	4.1~4.3	7.52	8.33	1.50	2.70	26.9	3.0~5.0			4160	935	Max.	4800	1079
4.0	15.7	4.0	12.6	5-4	4.1~4.3	7.52	8.33	1.50	2.70	26.9	5.0~7.0							
4.8	12.8	4.8	9.3	6-1	4.9~5.1	9.05	10.00	1.60	3.30	26.9	1.5~3.5	4000	899	4400	989	Min.	5100	1147
4.8	15.4	4.8	11.9	6-3	4.9~5.1	9.05	10.00	1.60	3.30	26.9	3.5~6.0			Max.	6900	1551		
4.8	18.4	4.8	14.9	6-4	4.9~5.1	9.05	10.00	1.60	3.30	26.9	6.0~8.5							
6.4	16.8	6.4	12.5	8-1	6.6~7.0	12.45	13.40	3.10	4.93	28.0	1.5~5.5	8000	1798	14300	3214	Min.		
6.4	20.8	6.4	16.5	8-2	6.6~7.0	12.45	13.40	3.10	4.93	28.0	5.0~9.0			Max.				

**Peel Type Blind Rivet**

Material	
1	Rivet Body - Aluminium 5056 Mandrel - Steel

Key Features	
1	Ideal for joining softer and more brittle materials such as plastics, rubber, wood GFRP or laminates.

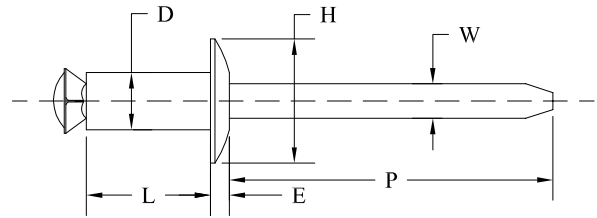
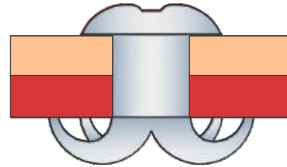

Peel Type Blind Rivet																						
Nom Rivet Size (Inch)	Nom Rivet Size (mm)	Rive Code	Hole Dia	Domed Head Dia		Head Height		Large Head Dia		Head Height		Mandrel Dia	Mandrel Protrusion	Domed Head Grip Range	Material Peel Type Rivet Body - Aluminium 5056 Mandrel - Steel							
				Min.	Max.	Min.	Max.	Min.	Max.	Min.	Max.				Tensile Min.	Shear Min.	Mandrel Break Load					
D	L	D	L	H		E		H		E		W	P	Material		Peel Type Rivet Body - Aluminium 5056		Mandrel - Steel				
-0.2	Max.	-0.2	Max.	Min.~Max.		Min. Max.		Min. Max.		Min. Max.		Nom	Min.	Min.~Max.		N	LBS	N	LBS	N	LBS	
1/8	1/4	3.2	6.4	4-1	3.3~3.4	6.0	6.6	1.0	9.1	9.9	1.6	1.9	27.0	0.5 ~ 1.6		720	160	800	180	Min.	1780	400
	5/16		8.0	4-2	3.3~3.4	6.0	6.6	1.0	9.1	9.9	1.6	1.9	27.0	1.6 ~ 3.2								
	3/8		9.6	4-3	3.3~3.4	6.0	6.6	1.0	9.1	9.9	1.6	1.9	27.0	3.2 ~ 4.8								
	1/2		12.7	4-4	3.3~3.4	6.0	6.6	1.0	9.1	9.9	1.6	1.9	27.0	4.8 ~ 6.4								
	5/8		15.9	4-5	3.3~3.4	6.0	6.6	1.0	9.1	9.9	1.6	1.9	27.0	6.4 ~ 9.6								
	3/4		19.3	4-6	3.3~3.4	6.0	6.6	1.0	9.1	9.9	1.6	1.9	27.0	9.6 ~ 12.7								
	1.0		25.4	4-7	3.3~3.4	6.0	6.6	1.0	9.1	9.9	1.6	1.9	27.0	16.0 ~ 19.0								
5/32	1/4	4.0	6.4	5-1	4.1~4.2	7.5	8.3	1.27	11.3	12.4	1.9	2.4	27.0	0.5 ~ 1.6		1160	260	1270	285	Min.	2668	600
	5/16		8.0	5-2	4.1~4.2	7.5	8.3	1.27	11.3	12.4	1.9	2.4	27.0	1.6 ~ 3.2								
	3/8		9.6	5-3	4.1~4.2	7.5	8.3	1.27	11.3	12.4	1.9	2.4	27.0	3.2 ~ 4.8								
	1/2		12.7	5-4	4.1~4.2	7.5	8.3	1.27	11.3	12.4	1.9	2.4	27.0	4.8 ~ 6.4								
	5/8		15.9	5-5	4.1~4.2	7.5	8.3	1.27	11.3	12.4	1.9	2.4	27.0	6.4 ~ 9.6								
	3/4		19.3	5-6	4.1~4.2	7.5	8.3	1.27	11.3	12.4	1.9	2.4	27.0	9.6 ~ 12.7								
	1.0		25.4	5-7	4.1~4.2	7.5	8.3	1.27	11.3	12.4	1.9	2.4	27.0	16.0 ~ 19.0								
3/16	1/4	4.8	6.4	6-1	4.9~5.0	9.0	10.0	1.52	15.2	16.5	2.3	2.8	27.0	0.5 ~ 1.6		1610	362	1870	420	Min.	3336	750
	5/16		8.0	6-2	4.9~5.0	9.0	10.0	1.52	15.2	16.5	2.3	2.8	27.0	1.6 ~ 3.2								
	3/8		9.6	6-3	4.9~5.0	9.0	10.0	1.52	15.2	16.5	2.3	2.8	27.0	3.2 ~ 4.8								
	1/2		12.7	6-4	4.9~5.0	9.0	10.0	1.52	15.2	16.5	2.3	2.8	27.0	4.8 ~ 6.4								
	5/8		15.9	6-5	4.9~5.0	9.0	10.0	1.52	15.2	16.5	2.3	2.8	27.0	6.4 ~ 9.6								
	3/4		19.3	6-6	4.9~5.0	9.0	10.0	1.52	15.2	16.5	2.3	2.8	27.0	9.6 ~ 12.7								
	1.0		25.4	6-7	4.9~5.0	9.0	10.0	1.52	15.2	16.5	2.3	2.8	27.0	16.0 ~ 19.0								
	1 1/4		31.8	6-8	4.9~5.0	9.0	10.0	1.52	15.2	16.5	2.3	2.8	27.0	22.4 ~ 25.4								
	1 1/2		38.1	6-9	4.9~5.0	9.0	10.0	1.52	15.2	16.5	2.3	2.8	27.0	28.6 ~ 31.8								
	2.0		50.8	6-10	4.9~5.0	9.0	10.0	1.52	15.2	16.5	2.3	2.8	27.0	31.8 ~ 35.0								

Rivet - Mate

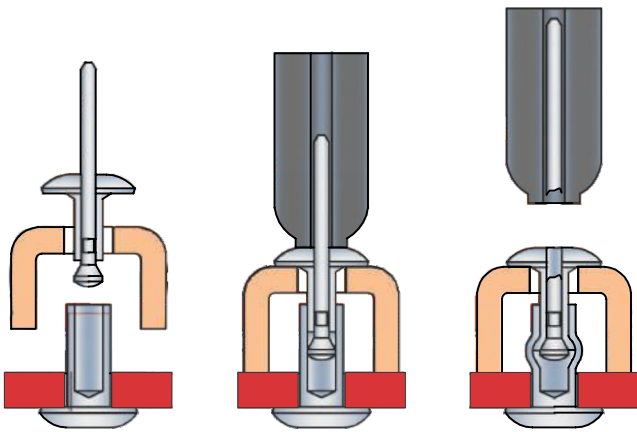

Material	
1	Rivet Body - Aluminium Mandrel - Aluminium
2	Rivet Body - Aluminium Mandrel - Steel
3	Rivet Body - Steel Mandrel - Steel

Key Features	
1	Extra-Wide grip range from 15.8mm to 98.4mm (5/8" to 3-7/8")
2	Large bearing area against both sides of the application spreads the tail bearing load/clamp load on the rear sheet to prevent damage
3	Clamps tightly and securely without crushing parent material
4	Excellent hole fill via radially expanded rivet body for a strong and vibration resistant joint
5	Rivet stem retained in tubular component avoids loose stems
6	Low profile headform on both sides of the application for a neat appearance

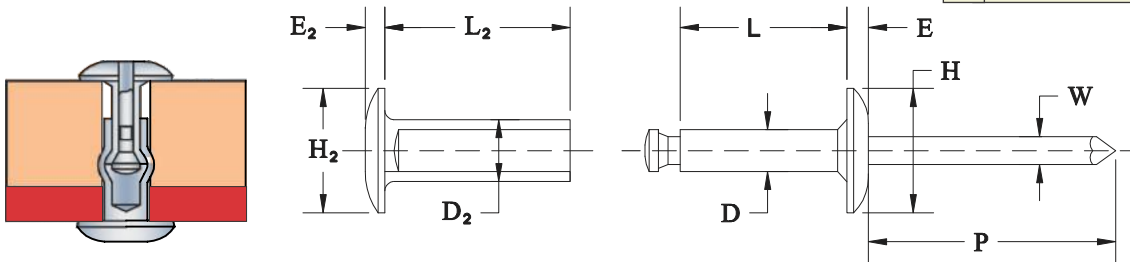

Rivet Mate															
Nom Rivet Size				Rivet Code	Hole Dia	Domed Head Dia		Head Height		Mandrel Dia	Mandrel Protrusion	Domed Head Grip Range	Tensile		
Size	D <sub>1</sub>	D <sub>2</sub>	L <sub>1</sub>	L <sub>2</sub>	Min.-Max.	H <sub>1</sub>	H <sub>2</sub>	E <sub>1</sub>	E <sub>2</sub>	W	P	Min.-Max.	Material	LBS Min.	
	Max.	Max.	Max.	Max.		Min.-Max.	Min.-Max.	Min.-Max.	Max.	Max.	Nom				Min.
3/16" (4.8)	3.2	4.8	13.4	15.0	6-1	6.4-5.0	9.0-10.0	9.0-10.0	1.5	1.5	2.0	27.0	16.0-19.0	Steel	N/A
				16.5	6-2								17.5-22.3		
				21.0	6-3								22.3-27.0		
				25.8	6-4								27.0-31.8	Aluminium	N/A
				30.5	6-5								31.8-36.5		
				35.2	6-6								36.5-41.3	Steel	N/A
				40.0	6-7								41.3-46.0	Aluminium	
				44.8	6-8								46.0-50.8	Aluminium	
				49.6	6-9								50.8-55.6		
				54.3	6-10								55.6-60.4		
1/4" (6.4)	4.8	6.4	11.3	15.0	7-1	7.9-8.0	15.3-16.0	15.3-16.0	2.4	2.4	3.0	31.7	16.0-19.0	Steel	
			11.3	17.7	7-2								19.0-22.5		
			20.8	7-3	22.5-28.5										
			27.2	7-4	28.5-35.0								Steel	450	
			33.6	7-5	35.0-41.5										
			40.0	7-6	41.5-47.8								Aluminium	450	
			46.3	7-7	47.8-54.0										
			52.6	7-8	54.0-60.5										
			59.0	7-9	60.5-66.8								Steel	247	
			65.3	7-10	66.8-73.0										
			71.7	7-11	73.0-79.5										
			78.0	7-12	79.5-85.8										
			84.4	7-13	85.8-92.0										
			90.7	7-14	92.0-98.5								Aluminium		

**Earth Type Blind Rivet**

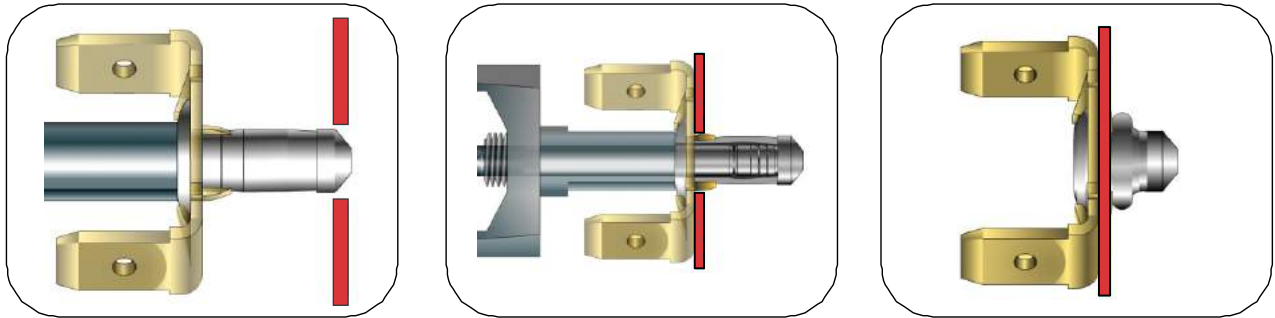

Material	
1	Rivet Body - Steel Mandrel - Steel

Key Features	
1	Twin tabs allow one or two connections
2	Fast installation of a one piece assembly
3	Works on a single phase power supply of 240 volts or below
4	Provides a resistance to or below 0.1 ohms
5	Tested and approved to EN 60335-1 and BS 3456 Parts 201, clauses 27, 28, 31
6	For 5.2mm holes and a material thickness of 1.0 - 1.5 mm
7	Steel body and stem with brass tab

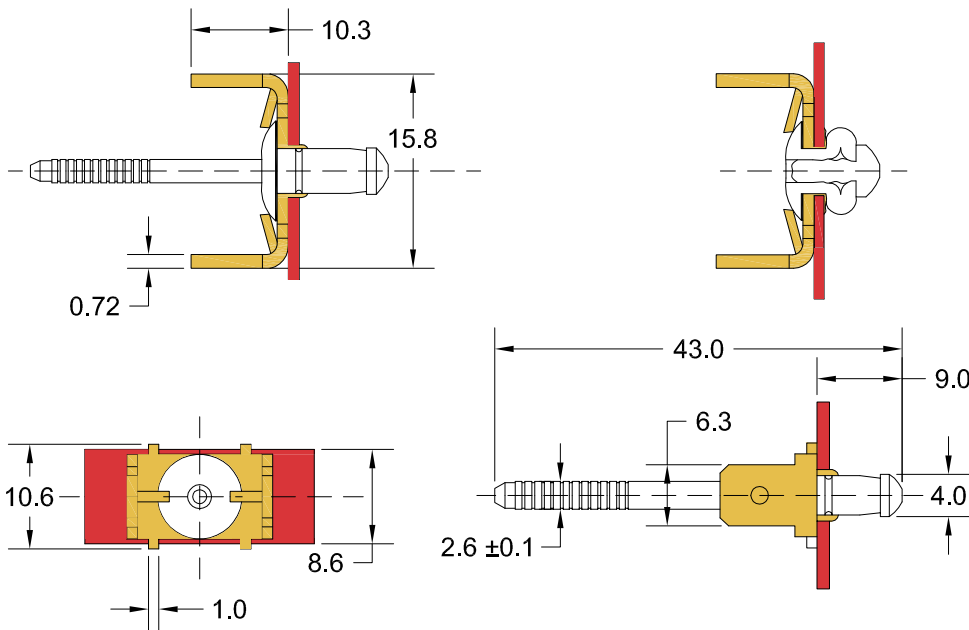

**GENERAL NOTES**

Material Body:	Steel
Material Stem:	Steel
Finishing Body:	Zinc Plated Clear Trivalent Passivated
Finishing Stem:	Zinc Plated Clear Trivalent Passivated
Grip Range:	1.0~1.5
Drill Size:	5.2 ± 0.05

Professional Hand Riveters



HR-702



HR-710



HR-730



HR-750



TC-901

Item No.	Weight (Gram)	Length (mm)	Type	Capacity
HR-702	530	255	Plier	Upto 4.0 For All Material & 4.8 In Aluminium
HR-710	1960	300 Closed, 810 Open	Lazy Tong	Upto 6.4 mm For All Material
HR-730	1845	540	Liver	Upto 6.4 mm For All Material
HR-750	1090	470	Liver	Upto 4.8 mm For All Material
TC-901	760	280	Swivel Head Plier	2.4 ~ 4.8 mm For All Material



**SRC Hydro Pneumatic Tool With Vaccum System**

Item No.	Weight	Air Pressure	Stroke	Capacity
SRC-A6	1.50 Kgs.	70-105 Psi	16 mm	Upto 4.8 mm For All Material
SRC-A8	1.74 Kgs.	75-105 Psi	18 mm	Upto 6.4 mm For All Material
SR-1	1.3 Kgs.	60-95 Psi	20 mm	Upto 4.8 mm For All Material
SR-2	1.45 Kgs.	70-95 Psi	20 mm	Upto 4.8 mm For All Material & 4.8 mm Monobolt Rivet
SR-3	1.70 Kgs.	70-95 Psi	26 mm	Upto 6.4 mm For All Material & 6.4 mm Monobolt Rivet

**SRC Hydro Pneumatic Tool Without Vaccum System**

Item No.	Weight	Air Pressure	Stroke	Capacity
SRC-55	1.5 Kgs.	70-90 Psi	14 mm	Upto 4.8 mm For All Material & 6.4 mm For Aluminium
SRC-56	1.6 Kgs.	70-90 Psi	14 mm	Upto 6.4 mm For All Material

**Lobster Hydro Pneumatic Tool Without Vacuum System**



AR-011M



AR-011P



AR-021M



AR-021EX



AR-021EXH

Item No.	Weight	Air Pressure	Stroke	Capacity
AR-011M	1.5 Kgs.	0.49-0.59 Mpa	14 mm	2.4, 3.2, 4.0 mm For All Material & 4.8 mm For Aluminium
AR-011P	1.5 Kgs.	0.49-0.59 Mpa	13 mm	2.4, 3.2, 4.0 mm For All Material & 4.8 mm For Aluminium
AR-021M	1.5 Kgs.	0.49-0.59 Mpa	14 mm	Upto 4.8 mm For All Material
AR-021EX	2.9 Kgs.	0.59-0.64 Mpa	26 mm	4.8, 6.4 MONOBOLT & STRUCTURAL RIVETS
AR-021EXH	2.9 Kgs.	0.59-0.64 Mpa	22 mm	Designed Specifically For 6.4 Megna Lok Structural Rivets

**Lobster Hydro Pneumatic Tool With Vacuum System**



R1A1



AR-2000MV



AR-2000HV

Item No.	Weight	Air Pressure	Stroke	Capacity
R1A1	1.09 Kgs.	0.49-0.59 Mpa	19 mm	Upto 4.8 mm For All Material
AR-2000MV	1.35 Kgs.	0.49-0.59 Mpa	16 mm	Upto 4.8 mm For All Material
AR-2000HV	1.8 Kgs.	0.49-0.59 Mpa	18 mm	4.8, 6.4 Monobolt & Structural Rivets

## Lobster Battery Tool For Blind Rivet



R1B1



R1B2

## Riveter Specification

Model No.	Type	Weight	Stroke	Jaw	Number of Riveting on a single charge	Compatible Rivets
R1B1	Cordless Riveter	1.9	22	Ultra Jaws 'M'	560	2.4, 3.2, 4.0, 4.8
R1B2	Cordless Riveter	2.0	22	Ultra Jaws 'L'	560	4.8, 6.4,
3.2 and 4.0 mm Rivets can be used if optional parts are attached						« 6.4 mm Stainless Steel rivets cannot be used

## Battery Pack Specifications

Model No.	Type	Voltage Rating	Capacity	Charging Time		Code No.
				Full Charge	Charge for Practical Use	
BPL1415	Li-ion	14.4 V DC	1.5 Ah	60 Min.	45 Min.	8860
BPL14	Li-ion	14.4 V DC	3.0 Ah	120 Min.	90 Min.	8856

## Charger Specifications

Model No.	Power	Code No.
BC0075G	100-240 V AC	(230V) 8900 (120V) 8896

## Zipp Hydro Pneumatic Tool With Vaccum System



ZT-1017 VS



ZT-0918 VS

Item No.	Weight	Air Pressure	Stroke	Capacity
ZT-1017 VS	1.95 Kgs.	70-90 Psi	17 mm	Upto 4.8 mm For All Material & 6.4 mm For Aluminium
ZT-0918 VS	1.8 Kgs.	70-90 Psi	18 mm	Upto 4.8 mm For All Material

## Our other Range of Products



Blind Rivet Nuts



Self Clinching Fasteners



Self Drilling Screws



Blind Rivet & Blind Rivet Nuts Tool



Panel fasteners



Lockbolt & Collar



### STATE ENTERPRISES

Plot No- 43, Street No.-1,  
Samaypur Industrial Area, Delhi - 110042 (India).  
Tel.: 91-11- 27837013 | Fax.: 91-11- 27834023  
Email id : sales@rivetsindia.com